

The page features a decorative design with three blue circles of varying sizes, each composed of concentric circles in different shades of blue. These circles are arranged vertically, with the largest at the top, a medium one in the middle, and a large one at the bottom right. Thin blue lines intersect the circles and extend across the page. A horizontal black line is positioned near the top left.

Honeywell CC-TA0X01 51308351-175

DATASHEET

CAMBIA AUTOMATION LIMITED
EMAIL: SALES@CAMBIA.CN

CAMBIA GROUP
2018/12/12

Specific solutions for PLC/DCS I/O cards

Specific solutions for PLC/DCS I/O cards	Honeywell C300 – General description	B.2
	Honeywell C300 – Selection guide	B.4
	Honeywell C300 – FTA C300 Input/output passive interface	B.6
	Honeywell C300 – FTA C300 Isolated interface per relay	B.10
	Honeywell C300 – Interconnection cables	B.11
	Cabling system with front adapters	B.12
	FAD – Selection guide	B.14
	FAD – Front Adapters for Siemens S7-300 and Rockwell Control-Logix	B.18
	RSF PLC – Passive interface for digital signals	B.24
	RSM – Isolated interfaces for digital signals	B.30
	MICRO-INTERFACE Solutions for PLC with relays and optos from the MICROSERIES family	B.34
	MICRO-PLC for GeFanuc 90-30 – Selection guide	B.36
	MICRO-PLC for GeFanuc RX3i – Selection guide	B.37
	MICRO-PLC for OMRON CJ1W – Selection guide	B.38
	MICRO-PLC for Rockwell Compact Logix – Selection guide	B.39
	MICRO-PLC for Rockwell Control Logix – Selection guide	B.40
	MICRO-PLC for Schneider M340 – Selection guide	B.41
	MICRO-PLC for Schneider MICRO-PREMIUM – Selection guide	B.42
	MICRO-PLC for Siemens S7-300 / ET-200M – Selection guide	B.43
	MICRO-PLC for Siemens S7-400 – Selection guide	B.44
	MICRO-INTERFACE digital	B.46
	MICROSERIES – Relay Couplers	B.48
	MICROSERIES – Solid-state relay	B.55

Field Terminal Assembly (FTA)

New interfaces for the Honeywell Experion® PKS C300 controller

Weidmüller's new interfaces and pre-assembled cables allow you to wire up I/O cards from Honeywell's C300 controller quickly and simply in the field.

The IOTAs (Input Output Terminal Assemblies) are designed using Weidmüller PCB connectors and terminals. This design gives you the flexibility to connect directly to the field cabling wire to wire or with a pre-assembled cable in combination with Weidmüller's FTAs. In comparison to traditional wire-to-wire cabling, the new Weidmüller FTAs and pre-cabling solution offer a highly efficient method of wiring between I/O modules and the field.

Concise wiring in the electrical cabinet is possible because multicore cables are used instead of individual wires. The cable harness can be delivered with double or single connectors and even with unterminated ends.

The housing provides easy handling as well as a safe, firm connection to the IOTA. It also allows you to use cables with large cross-sections.

Minimised wiring effort

Pluggable connectors and cables minimise the on site wiring effort.

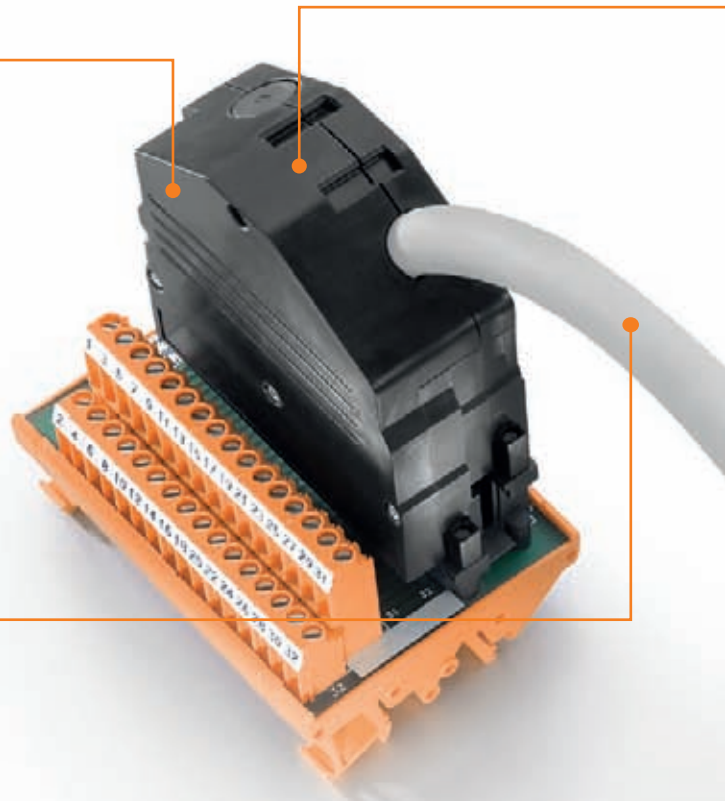

A quicker and easier connection

Pre-assembled wiring harnesses join IOTA and FTA with a fast and easy connection free from errors.



High current switching capability

The isolated digital output FTAs provide a high current switching capacity in a compact design.



Clear identification

The IOTA and FTA are delivered with the same Weidmüller connectors and the same orientation.



Excellent flexibility

The pre-assembled cables can be manufactured with different cross sections and in different lengths of up to 50 m.



Wide range of Weidmüller interfaces (FTA)

Weidmüller interfaces offer a large variety of functions such as LED indicators, insulators, relays or fuses for all the C300 I/O cards.

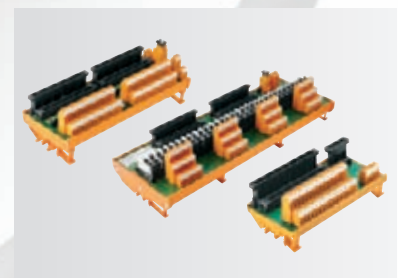

Honeywell C300 – Selection guide

The following selection guides enable you to quickly and easily choose the correct products according to your application needs:

- STEP 1:** Choose the IOTA to be used.
- STEP 2:** In this column you can find the number and type of cable required to make the connection.
- STEP 3:** Choose the most suitable interface for the application.

Example: For CC-TDIL01 it's possible to select different options.
 Solution 1: Pre-assembled cable C300-32B-320B (2 units)
 Interface: 1221550000 (1 unit)
 Solution 2: Pre-assembled cable C300-32B-320B (2 units)
 Interface: 1222980000 (2 units)

Selection Guide for pre-assembled cables and FTA for Honeywell C300 IOTA's

STEP 1		STEP 2		STEP 3													
Honeywell IOTA		Pre-assembled cables		FTA (Weidmüller Interfaces)													
Kind of Card	Card	Cable Type	Units / IOTA	Channels	Connection	1 LED per channel	Disconnect + Test points	Fuse per channel	External power supply connector	Isolation	Units / IOTA	Order No.	Type				
32 DI	CC-TDIL01 CC-TDIL11	C300-32B-320B	2	32					Yes		1	1221550000	FTA-C300-32DIOHV-S				
											1	1222940000	FTA-C300-32DILD-S				
											1	1221560000	FTA-C300-32DIOHV-Z				
											1	1222950000	FTA-C300-32DILD-Z				
											2	1222980000	FTA-C300-16AO-SH-S				
				16				No			No		No	2	1247140000	FTA-C300-16AI-TEST-S	
														2	1222990000	FTA-C300-16AO-SH-Z	
														2	1247150000	FTA-C300-16AI-TEST-Z	
														2	1223010000	FTA-C300-16AO-SHP	
														2	1223010000	FTA-C300-16AO-SHP	
32 DI High voltage	CC-TDI110 CC-TDI120 CC-TDI220 CC-TDI230	C300-32B-320B	2	32					Yes		1	1221550000	FTA-C300-32DIOHV-S				
											1	1221560000	FTA-C300-32DIOHV-Z				
											2	1222980000	FTA-C300-16AO-SH-S				
											2	1222990000	FTA-C300-16AO-SH-Z				
											2	1223010000	FTA-C300-16AO-SHP				
				32 DO	CC-TDOB01 CC-TDOB11	C300-32B-320B	2	32					Yes	Relay 6A	1	1221550000	FTA-C300-32DIOHV-S
															1	1221590000	FTA-C300-32DILD-S
															1	1246910000	FTA-C300-32DO-FUSE-S
															1	1221570000	FTA-C300-32DO-SLIM-S
															1	1221560000	FTA-C300-32DIOHV-Z
16								No			No		No	1	1221600000	FTA-C300-32DILD-Z	
														1	1246920000	FTA-C300-32DO-FUSE-Z	
														1	1221580000	FTA-C300-32DO-SLIM-Z	
														2	1222980000	FTA-C300-16IO-SH-S	
														2	1223020000	FTA-C300-16AO-TEST-S	
16 AO	CC-TAOX01 CC-TAOX11	C300-32B-320B	1	16					No		1	1222980000	FTA-C300-16AO-SH-S				
											1	1223020000	FTA-C300-16AO-TEST-S				
											1	1222990000	FTA-C300-16AO-SH-Z				
											1	1223030000	FTA-C300-16AO-TEST-Z				
											1	1223010000	FTA-C300-16AO-SHP				
				16 AI	CC-TAIX01 CC-TAIX11	C300-36B-320B	1	16					No		1	1247120000	FTA-C300-16AI-SH-S
															1	1247140000	FTA-C300-16AI-TEST-S
															1	1247130000	FTA-C300-16AI-SH-Z
															1	1247150000	FTA-C300-16AI-TEST-Z
															1	1247150000	FTA-C300-16AI-TEST-Z

Note:
 = Screw connection
 = Tension clamp connection
 = Pluggable connection

Email: sales@cambia.a.c

Honeywell C300 - FTA C300 Input/output passive interface

Honeywell C300 - FTA C300

Input/output passive interface for digital cards

Passive interfaces (FTA) for connecting the Honeywell C300 digital IOTAs.

- Clearly labelled: Same connector and position on the FTA and on the IOTA
- LED and fuse protection per channel (optional)
- Possibility of feeding the IOTA from the FTA (fuse protected)
- Screw or tension clamp connection

FTA-C300-32DI-LD

For: CC-TDIL01, CC-TDIL11

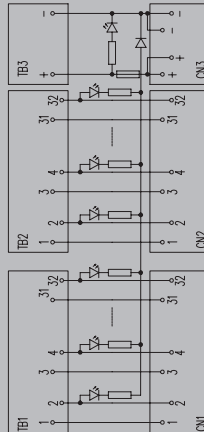

FTA-C300-32DIOHV

CC-TDIL01/11, CC-TDOB01/11, CC-TDI110/120/220/230

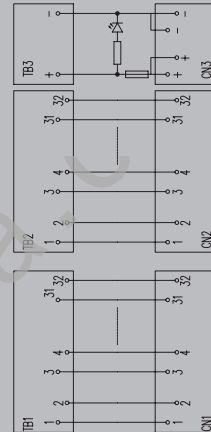

Technical data

Connection data and functionality	
Connection on control side	
LED status display per channel	
LED status of the supply voltage	
Fuse per channel	
Power supply fuse	
Type of test point	
Rated data	
Operating voltage	24 V DC ± 10%
Max. current per channel	1 A
Operating voltage (supply)	24 V DC ± 10%
General data	
Ambient temperature (operational)	-25...+50 °C
Storage temperature	-40...+60 °C
Approvals	CE
Insulation coordination (EN50178)	
Rated insulation voltage	< 50 V AC
Surge voltage category	III
Pollution severity level	2
Insulation test voltage	0.35 kVAC
Pulse voltage test (1,2/50µs)	0.8 kV
Dimensions	
Clamping range, min. /max. [Field]	
Clamping range, min. /max. [supply]	
Mounting rail	
Length x width	
Note	

Ordering data

Type	Height	Order No.
FTA-C300-32DI-LD-S	65 mm	1222940000
FTA-C300-32DI-LD-Z	65 mm	1222950000

Note

Accessories

Note	5x20 mm 0.63 A fuse 0439000000
------	--------------------------------

SLDV-THR 5.08	
green	
yellow	
No	
630 mA	
No	
Screw connection	
0.13 mm ² / 6 mm ²	0.13 mm ² / 2.5 mm ²
0.13 mm ² / 6 mm ²	0.13 mm ² / 2.5 mm ²
TS 32, TS 35	TS 32, TS 35
216 mm / 87 mm	216 mm / 87 mm
Tension clamp connection	
0.13 mm ² / 6 mm ²	0.13 mm ² / 2.5 mm ²
0.13 mm ² / 6 mm ²	0.13 mm ² / 2.5 mm ²
TS 32, TS 35	TS 32, TS 35
216 mm / 87 mm	216 mm / 87 mm
Screw connection	
0.13 mm ² / 6 mm ²	0.13 mm ² / 2.5 mm ²
0.13 mm ² / 6 mm ²	0.13 mm ² / 2.5 mm ²
TS 32, TS 35	TS 32, TS 35
216 mm / 87 mm	216 mm / 87 mm
Tension clamp connection	
0.13 mm ² / 6 mm ²	0.13 mm ² / 2.5 mm ²
0.13 mm ² / 6 mm ²	0.13 mm ² / 2.5 mm ²
TS 32, TS 35	TS 32, TS 35
216 mm / 87 mm	216 mm / 87 mm
For digital outputs, replace the fuse as required (max. 5 A). TB3 can only be used for 24 V DC.	

Type	Height	Order No.
FTA-C300-32DIOHV-S	65 mm	1221550000
FTA-C300-32DIOHV-Z	65 mm	1221560000

Note

Note	5x20 mm 0.63 A fuse 0439000000; 5x20 mm 5 A fuse 0431300000
------	---

SLDV-THR 5.08	
No	
yellow	
No	
630 mA	
No	
Screw connection	
0.13 mm ² / 6 mm ²	0.13 mm ² / 2.5 mm ²
0.13 mm ² / 6 mm ²	0.13 mm ² / 2.5 mm ²
TS 32, TS 35	TS 32, TS 35
216 mm / 87 mm	216 mm / 87 mm
Tension clamp connection	
0.13 mm ² / 6 mm ²	0.13 mm ² / 2.5 mm ²
0.13 mm ² / 6 mm ²	0.13 mm ² / 2.5 mm ²
TS 32, TS 35	TS 32, TS 35
216 mm / 87 mm	216 mm / 87 mm
For digital outputs, replace the fuse as required (max. 5 A). TB3 can only be used for 24 V DC.	

Type	Height	Order No.
FTA-C300-32DIOHV-S	65 mm	1221550000
FTA-C300-32DIOHV-Z	65 mm	1221560000

Note

Note	5x20 mm 0.63 A fuse 0439000000; 5x20 mm 5 A fuse 0431300000
------	---

FTA-C300-32DO-LD

For: CC-TD0B01, CC-TD0B11

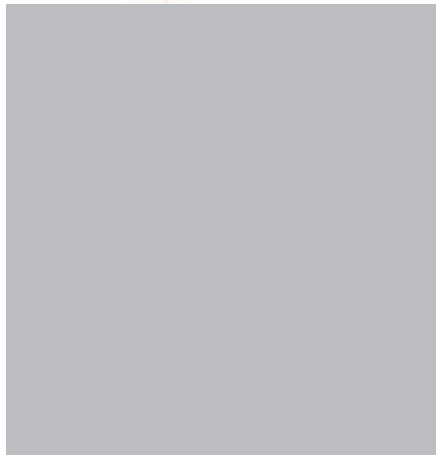

SLDV-THR 5.08
green
yellow
No
5 A
No
24 V DC ± 10%
1 A
24 V DC ± 10%
-25...+50°C
-40...+60 °C
CE
< 50 V AC
III
2
0.35 kVAC
0.8 kV

Screw connection	Tension clamp connection
0.13 mm ² / 6 mm ²	0.13 mm ² / 2.5 mm ²
0.13 mm ² / 6 mm ²	0.13 mm ² / 2.5 mm ²
TS 32, TS 35	TS 32, TS 35
216 mm / 87 mm	216 mm / 87 mm

Type	Height	Order No.
FTA-C300-32DO-LD-S	65 mm	1221590000
FTA-C300-32DO-LD-Z	65 mm	1221600000

5x20 mm 5 A fuse 0431300000

FTA-C300-32DO-FUSE

For: CC-TD0B01, CC-TD0B11

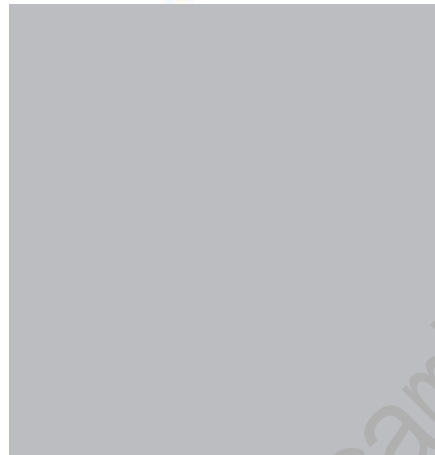

SLDV-THR 5.08
No
yellow
500 mA
5 A
No
24 V DC ± 10%
1 A
24 V DC ± 10%
-25...+50°C
-40...+60 °C
CE
< 50 V AC
III
2
0.35 kVAC
0.8 kV

Screw connection	Tension clamp connection
0.13 mm ² / 6 mm ²	0.13 mm ² / 2.5 mm ²
0.13 mm ² / 6 mm ²	0.13 mm ² / 2.5 mm ²
TS 35 x 15	TS 35 x 15
217 mm / 133 mm	217 mm / 133 mm

Type	Height	Order No.
FTA-C300-32DO-FUSE-S	95 mm	1246910000
FTA-C300-32DO-FUSE-Z	95 mm	1246920000

5x20 mm 5 A fuse 0431300000

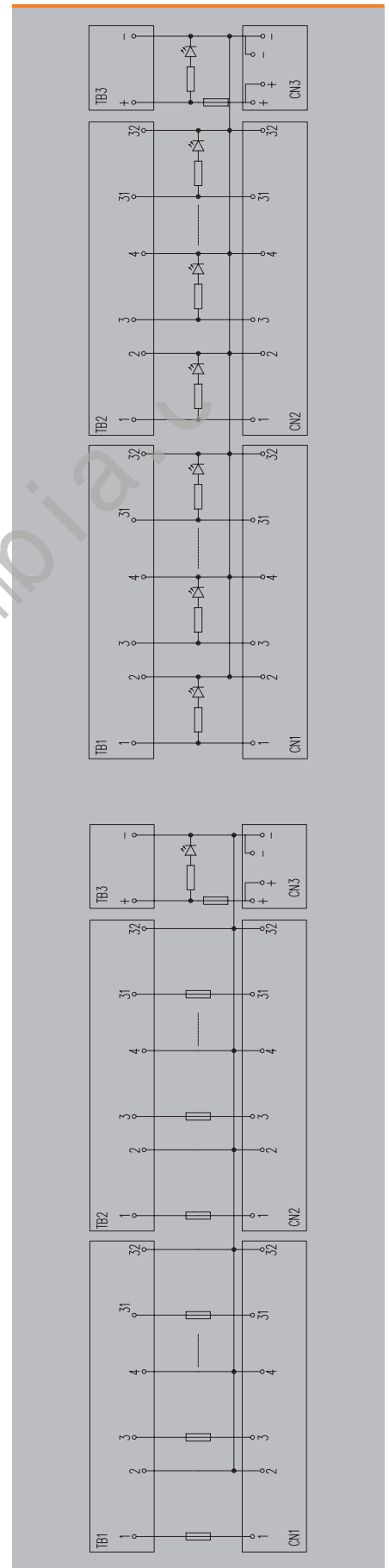

Honeywell C300 - FTA C300 Input/output passive interface

Honeywell C300 - FTA C300

Input/output passive interface for analogue and digital cards

Passive interfaces (FTA) for connecting the Honeywell C300 analogue IOTAs.

- Same connector and position on the FTA and on the IOTA
- 2 units can also be used for digital IOTAs
- Disconnecting plugs and test points (2 mm in diameter) for voltage and current measurements
- M4 connection for the shielding

FTA-C300-16AI-SH

For: CC-TAIX01, CC-TAIX11



FTA-C300-16AI-TEST

For: CC-TDIL01, CC-TDIL11, CC-TAIX01, CC-TAIX11

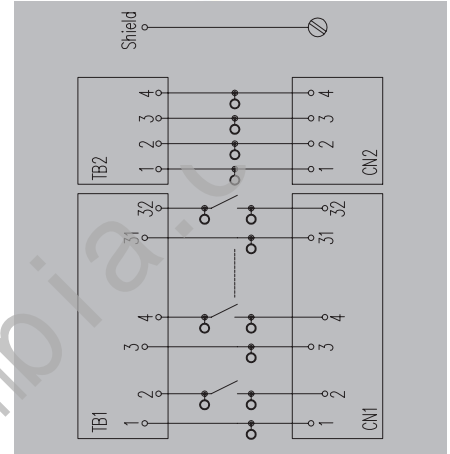
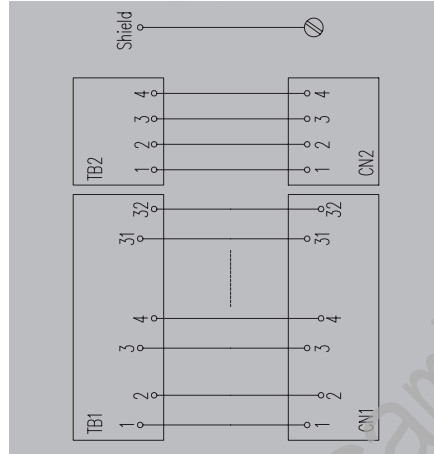
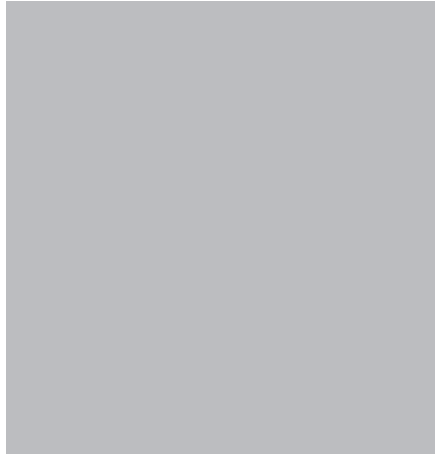

Technical data

Connection data and functionality	
Connection on control side	
LED status display per channel	
LED status of the supply voltage	
Fuse per channel	
Power supply fuse	
Type of test point	
Rated data	
Operating voltage	250 V AC / 350 V DC
Max. current per channel	1 A
Operating voltage (supply)	
General data	
Ambient temperature (operational)	-25...+50°C
Storage temperature	-40...+60 °C
Approvals	CE
Insulation coordination (EN50178)	
Rated insulation voltage	< 250 V AC
Surge voltage category	II
Pollution severity level	2
Insulation test voltage	1.2 kVAC
Pulse voltage test (1,2/50µs)	2 kV
Dimensions	
Clamping range, min. /max. [Field]	0.13 mm ² / 6 mm ²
Clamping range, min. /max. [supply]	0.13 mm ² / 6 mm ²
Mounting rail	TS 35, TS 32
Length x width	135 mm / 70 mm
Note	

SLDV-THR 5.08	
No	
No	
No	
No	
No	
Diameter: 2 mm	
24 V DC ± 10%	
1 A	
-25...+50°C	
-40...+60 °C	
CE	
< 250 V AC	
II	
2	
1.2 kVAC	
2 kV	
Screw connection	Tension clamp connection
0.13 mm ² / 6 mm ²	0.13 mm ² / 2.5 mm ²
0.13 mm ² / 6 mm ²	0.13 mm ² / 2.5 mm ²
TS 35, TS 32	TS 35, TS 32
135 mm / 70 mm	135 mm / 70 mm
Note	

SLDV-THR 5.08	
No	
No	
No	
No	
No	
Diameter: 2 mm	
24 V DC ± 10%	
1 A	
-25...+50°C	
-40...+60 °C	
CE	
≤ 50 V DC	
III	
2	
0.35 kVAC	
0.8 kV	
Screw connection	Tension clamp connection
0.13 mm ² / 6 mm ²	0.13 mm ² / 2.5 mm ²
0.13 mm ² / 6 mm ²	0.13 mm ² / 2.5 mm ²
TS 35 x 15	TS 35 x 15
141 mm / 133 mm	141 mm / 133 mm
Note	

Ordering data

Type	Height	Order No.
FTA-C300-16AI-SH-S	56 mm	1247120000
FTA-C300-16AI-SH-Z	56 mm	1247130000
Note		
Screw connection		
Tension clamp connection		
Plug-in connection		
Accessories		
Note		

Type	Height	Order No.
FTA-C300-16AI-TEST-S	95 mm	1247140000
FTA-C300-16AI-TEST-Z	95 mm	1247150000
Note		
Test plug PS 2.0 MC 0310000000		

Type	Height	Order No.
FTA-C300-16AI-TEST-S	95 mm	1247140000
FTA-C300-16AI-TEST-Z	95 mm	1247150000
Note		
Test plug PS 2.0 MC 0310000000		

FTA-C300-16AO-SH

CC-TDOB01/11,TDI 110/120/220/230/L01/L11,TAOX01/11



FTA-C300-16AO-TEST

For: CC-TDOB01, CC-TDOB11, CC-TAOX01, CC-TAOX11

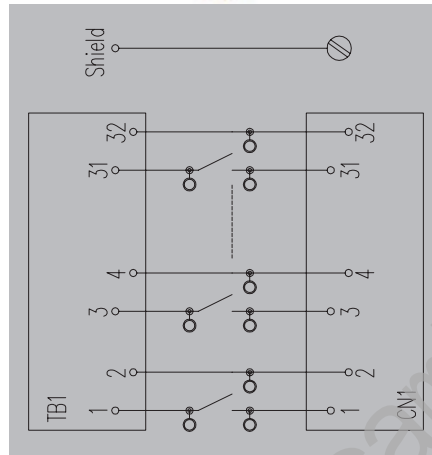
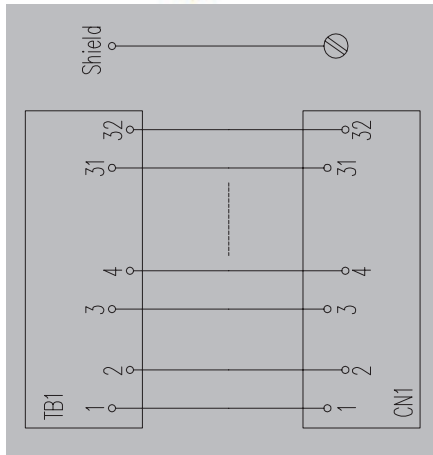

SLDV-THR 5.08
No
No
No
No
No
250 V AC / 350 V DC
1 A

-25...+50°C
-40...+60 °C
CE
< 250 V AC
II
2
1.2 kVAC
2 kV

Screw connection	Tension clamp connection
0.13 mm ² / 6 mm ²	0.13 mm ² / 2.5 mm ²
0.13 mm ² / 6 mm ²	0.13 mm ² / 2.5 mm ²
TS 35, TS 32	TS 35, TS 32
105 mm / 70 mm	105 mm / 70 mm

The power connector is not supplied in the interface for digital cards

Type	Height	Order No.
FTA-C300-16AO-SH-S	56 mm	1222980000
FTA-C300-16AO-SH-Z	56 mm	1222990000
FTA-C300-16AO-SH-P	56 mm	1223010000

SLDV-THR 5.08
No
No
No
No
Diameter: 2 mm
24 V DC ± 10%
1 A

-25...+50°C
-40...+60 °C
CE
≤ 50 V DC
III
2
0.35 kVAC
0.8 kV

Screw connection	Tension clamp connection
0.13 mm ² / 6 mm ²	0.13 mm ² / 2.5 mm ²
0.13 mm ² / 6 mm ²	0.13 mm ² / 2.5 mm ²
TS 35 x 15	TS 35 x 15
110 mm / 133 mm	110 mm / 133 mm

The power connector is not supplied in the interface for digital cards

Type	Height	Order No.
FTA-C300-16AO-TEST-S	95 mm	1223020000
FTA-C300-16AO-TEST-Z	95 mm	1223030000

Test plug PS 2.0 MC 0310000000

Honeywell C300 - FTA C300 Isolated interface per relay

Honeywell C300 - FTA C300

Isolated output interface for digital cards

Passive interfaces (FTA) for connecting the Honeywell C300 analogue IOTAs.

- Clearly labelled: Same connector and position on the FTA and on the IOTA
- Input/output reinforced insulation (basic between contacts)
- Possibility of powering the IOTA from the FTA
- Screw or tension clamp connection

FTA-C300-32DO-RSLIM

For: CC-TD0B01, TD0B11

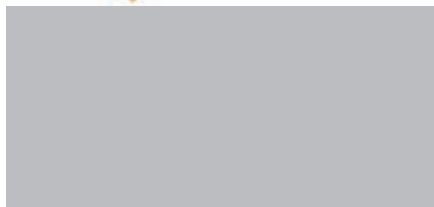

Technical data

Connection data and functionality

Connection on control side
 Number of poles (control side)
 Relay type
 LED status display per relay
 LED status of the supply voltage
 Fuse per relay
 Power supply fuse

Nominal supply data

Input voltage
 Input current
 Operating voltage (supply)

Nominal output data

Contact material
 Operating voltage
 Max. AC continuous current

General data

Ambient temperature (operational)
 Storage temperature
 Approvals

Insulation coordination (EN50178)

Rated input insulation voltage
 Rated output insulation voltage
 Overvoltage category input/output
 Overvoltage category output/output
 Pollution severity level
 Pulse voltage test (1,2/50µs)
 Insulation test voltage
 Clearance input/output

SLDV-THR 5.08

64-pole

RSS

green

yellow

No

5 A

24 V DC ± 10%

13 mA

24 V DC ± 10%

AgNi 90/10

250 V

4 A

-25...+50°C

-40...+60°C

CE

< 50 V AC

< 250 V AC

III

II

2

6 kV

1.2 kVAC

≥ 5.5 mm

Dimensions

Clamping range, min. /max. [Field]
 Clamping range, min. /max. [supply]
 Mounting rail
 Length x width

Note

Screw connection

0.13 mm² / 6 mm²

0.13 mm² / 6 mm²

TS 35 x 15

368 mm / 133 mm

Tension clamp connection

0.13 mm² / 2.5 mm²

0.13 mm² / 2.5 mm²

TS 35 x 15

368 mm / 133 mm

Ordering data

Screw connection
 Tension clamp connection

Type	Height	Order No.
FTA-C300-32DO-RSLIM-S	95 mm	1221570000
FTA-C300-32DO-RSLIM-Z	95 mm	1221580000

Note

Accessories

Note

5x20 mm 5 A fuse 0431300000

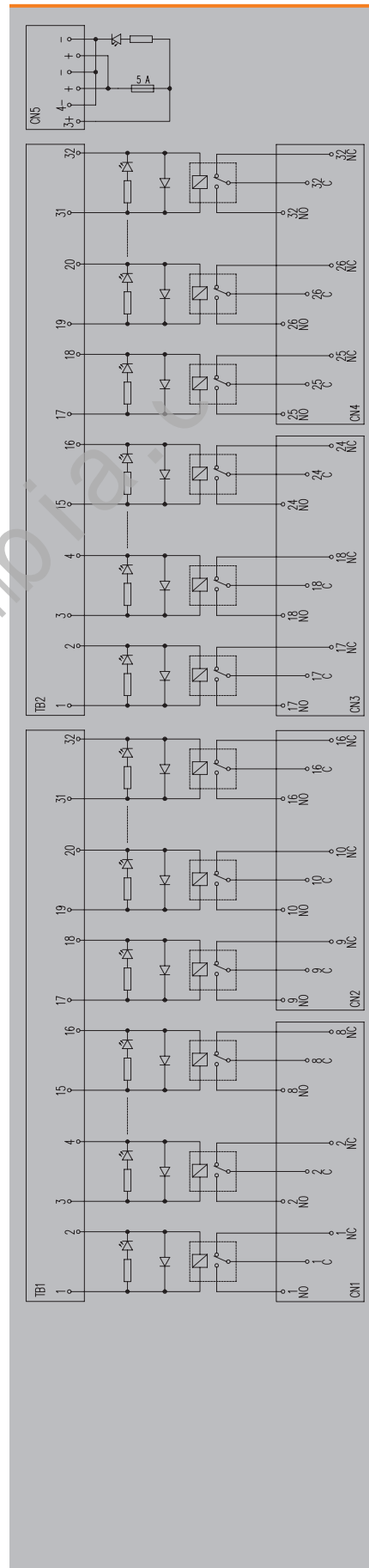

Honeywell C300 - Interconnection cables

Pre-built cables for connecting the CS300 cards to the Weidmüller interfaces. 2 ranges:

- Premium: With housing for the connector
- Basic: Without housing for the connector

C300-32

Premium Range



C300-32

Basic Range

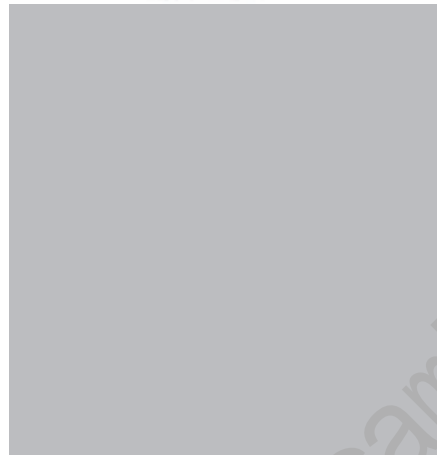
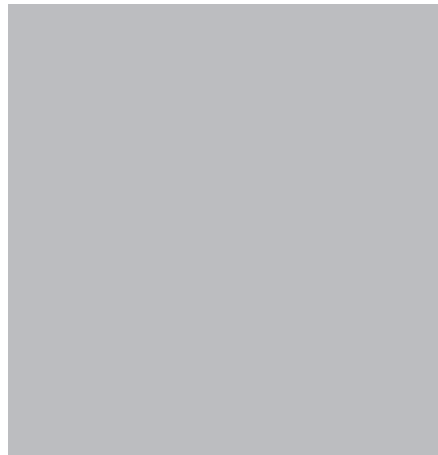

Technical data

Rated data
Capacity wire / shield
Capacity wire / wires
Cable features
Cable
Material
General data
Ambient temperature (operational)
Storage temperature

300 pF/m
300 pF/m
Cable LiYCY
PVC
-10...+50°C
-10...+60 °C

300 pF/m
300 pF/m
Cable LiYCY
PVC
-10...+50°C
-10...+60 °C

Note

Resistance value according to the wire cross-section. See www.weidmueller.com
--

Resistance value according to the wire cross-section. See www.weidmueller.com
--

Ordering data

32-pole
32-pole
32-pole
32-pole
32-pole + 4-pole
32-pole + 4-pole
32-pole + 4-pole
32-pole + 4-pole

Type	Qty.	Order No.
C300-32B-320B-2S-M14-01	1	7789887010
C300-32B-320B-2S-M25-01	1	7789828010
C300-32B-320B-2S-M34-01	1	7789888010
C300-32B-320B-2S-M50-01	1	7789838010
C300-36B-324B-2S-M14-01	1	7789890010
C300-36B-324B-2S-M25-01	1	7789829010
C300-36B-324B-2S-M34-01	1	7789891010
C300-36B-324B-2S-M50-01	1	7789892010

Type	Qty.	Order No.
PAC-C300-3232-14-01	1	7789879010
PAC-C300-3232-25-01	1	7789880010
PAC-C300-3232-34-01	1	7789881010
PAC-C300-3232-50-01	1	7789882010
PAC-C300-3636-14-01	1	7789883010
PAC-C300-3636-25-01	1	7789884010
PAC-C300-3636-34-01	1	7789885010
PAC-C300-3636-50-01	1	7789837010

Note

The last 3 digits of the cable code indicate its length. For example, if the code ends in 100, the cable would be 10 m long.
--

The last 3 digits of the cable code indicate its length. For example, if the code ends in 100, the cable would be 10 m long.
--

Accessories

Note

--

--

PLC Front Adapter (FAD)

New Front Adapters for different PLC Cards.

Easy and fast field wiring on PLC I/O cards with new front adapters.

B In comparison to traditional wire-to-wire cabling, the new front adapters (FAD), in combination with Weidmüller's interface range, offer a much more efficient method for field wiring on PLCs' I/O cards.

Both can be connected to the standard active or passive interfaces range or to the relays or optos from Weidmüller's MICROSERIES. But the method with FADs is significantly easier and faster than with traditional wire-to-wire cabling. The pre-assembled cables are available in different lengths.



Large Range

The front adapters are available for many different PLC I/O cards, including Siemens S7300 and S7400, Rockwell Control and Compact Logix, Ge-Fanuc and Schneider. Dependent on the PLC I/O card, the cables are available with or without housing.



Simple and Safe

Minimised wiring effort on site thanks to plug-type connectors and cables. No wiring errors. Clear wiring in the cabinet due to the cable system instead of individual wires.



High Flexibility

A wide range of interfaces can be connected with the FADs and the pre-assembled cables. Weidmüller's interface range offers interesting features, including: LED, fuse, disconnections, relays and optos with manual coil connection (optional). Individual modules from the MICROSERIES family can be directly assembled in groups of eight and connected to the PLC (by standard cable and the appropriate PLC front adapter).

B



Time-saving

Reduced planning and design times. Less time required for commissioning and troubleshooting.



FAD – Selection guide

Front adapter selection table for PLC (FAD) and interface modules.

Front adapters for PLCs (FAD-UNIV) are an easy solution for wiring I/O and supply signals from the PLC to the applications. Each signal is taken at a 1:1 relation to the RSF ribbon connector (digital signals) or SUB-D (analogue signals) using adequate (PAC) pre-assembled cables (table 1). In addition, we offer a wide range of interfaces (active and passive) for the cards of several major manufacturers that allow the use of our MICROSERIES opto modules and relays.









Selection table:

Choose your PLC card in steps 1 to 3. In step 4 you will find the PLC (FAD) front adapters, the pre-assembled cable (PAC) and the group of interfaces that can be used (in Table 1 or Table 2). In step 5, choose the most adequate interface for your application.

Table 1: Universal FAD

STEP 1: PLC Manufacturer	STEP 2: Identify the type of connector of your PLC I/O card	STEP 3: Choose between analogical and digital I/O	STEP 4: Selected articles		
			PLC Front adapters (FAD)	Pre-assembled cable (PAC) ⁽¹⁾	Choose the interface module
Siemens S7-300	Input/output cards with 20 pole connector	Digital cards	1127840000 FAD S7/300 HE20 UNIV	7789806LLL	RSF 20 GROUP
		Analogue cards	1127840000 FAD S7/300 HE20 UNIV	7789807LLL	RSSD 25 GROUP
	Input/output cards with 40 pole connector	Digital cards	1127870000 FAD S7/300 HE40 UNIV	7789808LLL	RSF 40 GROUP
		Analogue cards	1127870000 FAD S7/300 HE40 UNIV	7789802LLL	RSSD 50 GROUP
Rockwell Control-Logix	Input/output cards with 20 pole connector	Digital cards	1127900000 FAD CTLX HE20 UNIV	7789806LLL	RSF 20 GROUP
		Analogue cards	1127900000 FAD CTLX HE20 UNIV	7789807LLL	RSSD 25 GROUP
	Input/output cards with 36 pole connector	Digital cards	1127920000 FAD CTLX HE 40 UNIV	7789808LLL	RSF 40 GROUP
		Analogue cards	1127920000 FAD CTLX HE 40 UNIV	7789802LLL	RSSD 50 GROUP

(1) LLL means length of cable in dm Example LLL = 100 means 10 meters from end to end of the cable without measuring the connectors.
Universal solution for all cards with service voltage ≤ 30 V AC 60 V DC

STEP 5: Selected interface module (see chapter C)					
	Compact version	Connection		Type	Order No.
		Screw	Tension clamp		
RSF 20 GROUP				RS F20 Z	8537110000
				RS F20 LP2N 5/20	0224261001
RSF 40 GROUP				RS F40 Z	8537140000
				RS F40 LP2N 5/40	0224461001
RSSD 25 GROUP				RS SD25 SZ	8537370000
				RS SD25S UNC 4.40 LP2N	8005181001
RSSD 50 GROUP				RS SD50 SZ	8537350000
				RS SD50S UNC 4.40 LP2N	8005161001

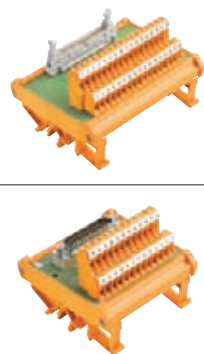

Table 2: Specific FAD

STEP 1: PLC Manufacturer	STEP 2: Identify the I/O card of PLC	STEP 3: Choose the required field system	STEP 4: Selected articles				
			PLC Front adapters (FAD)	Pre-assembled cable (PAC) ⁽¹⁾	Choose the interface module		
					Passive modules	Relay modules/ opto modules	
Siemens S7-300	6ES7 321-1BH01-0AA0	INTERFACE	1127850000 FAD S7/300 HE20 16 DIO	7789806LLL	H2016 GROUP		
	6ES7 321-1BH81-0AA0	MICROSERIES	1127850000 FAD S7/300 HE20 16 DIO	7789810LLL		MICRO 16I GROUP	
	6ES7 321-1BH50-0AA0						
	6ES7 321-7RD00-0AB0						
	6ES7 321-1BL00-0AA0	INTERFACE	1127890000 FAD S7/300 HE40 32DIO	7789808LLL		RS32 GROUP	
	6ES7 321-1BL80-0AA0	MICROSERIES	1127880000 FAD S7/300 2XHE20 32DIO	7789810LLL (2 units)			MICRO 32I GROUP
	6ES7 322-1BH01-0AA0	INTERFACE	1127850000 FAD S7/300 HE20 16 DIO	7789806LLL	H2016 GROUP		O2016 GROUP
	6ES7 322-1BH81-0AA0	MICROSERIES	1127850000 FAD S7/300 HE20 16 DIO	7789810LLL			MICRO 16O GROUP
Rockwell Control-Logix	6ES7 322-1BL00-0AA0	INTERFACE	1127890000 FAD S7/300 HE40 32DIO	7789808LLL	RS32 GROUP	RSM-32 GROUP	
	6ES7 322-1BL80-0AA0	MICROSERIES	1127880000 FAD S7/300 2XHE20 32DIO	7789810LLL (2 units)		MICRO 32O GROUP	
	1756-IB16	INTERFACE	1127910000 FAD CTLX HE20 16DI	7789806LLL	H2016 GROUP		
	1756-IC16	MICROSERIES	1127910000 FAD CTLX HE20 16DI	7789810LLL			MICRO 16I GROUP
	1756-IN16						
	1756-IB32	INTERFACE	1127940000 FAD CTLX HE40 32DI	7789808LLL	RS32 GROUP		RSM-32 GROUP
		MICROSERIES	1127930000 FAD CTLX 2XHE20 32DI	7789810LLL (2 units)			MICRO 32I GROUP
	1756-OB16E	INTERFACE	1127950000 FAD CTLX HE20 16DO	7789806LLL	H2016 GROUP		O2016 GROUP
1756-OV16E	MICROSERIES	1127950000 FAD CTLX HE20 16DO	7789810LLL			MICRO 16O GROUP	
1756-OB32	INTERFACE	1127980000 FAD CTLX HE40 32DO	7789808LLL	RS32 GROUP		RSM-32 GROUP	
	MICROSERIES	1127990000 FAD CTLX 2XHE20 32DO	7789810LLL (2 units)			MICRO 32O GROUP	

(1) LLL means length of cable in dm Example LLL = 100 means 10 meters from end to end of the cable without measuring the connectors.

STEP 5: Interface selection

H2016 GROUP

Type		Connection		LED by channel	Disconnectable	Fuse	Order No.	Interfaces			
Family	Type of wiring	Screw	Tension clamp connection					Type	Page		
H2016	1-wire						9445700000	RS 16IO 1W H S	A.43		
							9445710000	RS 16IO 1W L H S	A.43		
								1311750000	RS 16IO 1W H Z	A.43	
								1311770000	RS 16IO 1W L H Z	A.43	
		2-wire							9445810000	RS 16IO 1W HL H S	A.44
									1311780000	RS 16IO 1W HL H Z	A.44
								9445720000	RS 16IO 2W H S	A.45	
								9445730000	RS 16IO 2W L H S	A.45	
								1311790000	RS 16IO 2W H Z	A.45	
								1311800000	RS 16IO 2W L H Z	A.45	
	3-wire							1311800000	RS 16IO 2W L H S	A.46	
								9445750000	RS 16IO 2W HL H S	A.46	
								1311820000	RS 16IO 2W I H Z	A.46	
								1311830000	RS 16IO 2W HL H Z	A.46	
								9445820000	RS 16IO 2W F H S	A.47	
								1311850000	RS 16IO 2W F-L H S	A.47	
							1311840000	RS 16IO 2W F H Z	A.47		
							1311870000	RS 16IO 2W F-L H Z	A.47		
						9445760000	RS 16IO 3W H S	A.48			
						9445770000	RS 16IO 3W L H S	A.48			
						1311880000	RS 16IO 3W H Z	A.48			
						1311890000	RS 16IO 3W L H Z	A.48			



Versions with LED only for cards with nominal voltage of 24 V DC

O2016 GROUP

Type of Interface		Features							Interfaces				
Number of channels	Family	Design	Connection		Voltage	Type of contact	Fuse	Switch (coil)	Switch (contact)	Order No.	Type	Page	
			Screw	Tension clamp connection									
16-channel	O2016				24 V DC	1CO				1129010000	RSM-16 PLC C 1CO S	A.75	
										1290300000	RSM-16 PLC C SW 1CO S	A.75	
										1129020000	RSM-16 PLC C 1CO Z	A.75	
										1129040000	RSM-16 PLC C SW 1CO Z	A.75	
		1 line			24 V DC (+/-)	1CO					1129100000	RSM-16 PLC 1CO S	A.76
											1129120000	RSM-16 PLC SW 1CO S	A.76
		1 line			24 V DC (+/-)	1CO					1129110000	RSM-16 PLC 1CO Z	A.76
											1129130000	RSM-16 PLC SW 1CO Z	A.76
		2 lines			24 V DC	1CO					9445100000	RSM-16 C 1CO S	A.77
											9447100000	RSM-16 C 1CO Z	A.77
		1 line			24 V DC	1CO					9444610000	RSM-16 24V(-/+) 1CO S	A.78
											9444660000	RSM-16 24V(-/+) 1CO Z	A.78
		1 line			24 V DC	1CO					9445160000	RSM-16 2CO S	A.79
											9447160000	RSM-16 2CO Z	A.79
		1 line			24 V DC	1CO					9445120000	RSM-16 FUS 1CO S	A.80
											9447120000	RSM-16 FUS 1CO Z	A.80
		1 line			24 V DC	1CO					9445140000	RSM-16 FOR 1CO S	A.81

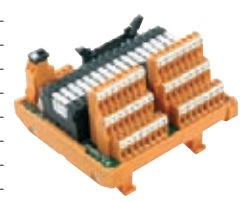

RS32 GROUP

Type of wiring	Connection		LED by channel	Fuse	Order No.	Type	Page	
	Screw	Tension clamp connection						
1-wire						8428880000	RS F40 I/O32 LMZF	B.24
						1128140000	RSF PLC 1W 32IO S	B.24
						1128160000	RSF PLC 1W 32IO LEDS S	B.25
						1128150000	RSF PLC 1W 32IO Z	B.24
						1128170000	RSF PLC 1W 32IO LEDS Z	B.25
2-wire						1128180000	RSF PLC 2W 32IO S	B.26
						1128200000	RSF PLC 2W 32IO LEDS S	B.26
						1128190000	RSF PLC 2W 32IO Z	B.26
						1128210000	RSF PLC 2W 32IO LEDS Z	B.26
						1128240000	RSF PLC 2W 32IO FUS S	B.27
						1128250000	RSF PLC 2W 32IO FUS Z	B.27
3-wire						8430980000	RS F40 INIT32 LMZF	B.28
						8428900000	RS F40 INIT32 LD LMZF	B.29

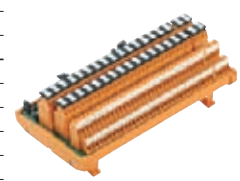

FAD - Selection guide

STEP 5: Interface selection

RSM-32 GROUP

Type of Interface		Design	Funcionalidades		Type of contact	Switch (coil)	Order No.	Interfaces	Page	
Number of channels	Family		Connection							
			Screw	Tension clamp connection						
32-channel	RSM-32	><			1CO		1129050000	RSM-32 PLC C 1CO S	B.31	
		><			1CO		1129080000	RSM-32 PLC C SW 1CO S	B.31	
		><			1CO			1129070000	RSM-32 PLC C 1CO Z	B.31
		><			1CO		1129090000	RSM-32 PLC C SW 1CO Z	B.31	
					1CO			1129140000	RSM-32 PLC 1CO S	B.32
					1CO		1129170000	RSM-32 PLC SW 1CO S	B.32	
					1CO			1129150000	RSM-32 PLC 1CO Z	B.32
					1CO		1129180000	RSM-32 PLC SW 1CO Z	B.32	

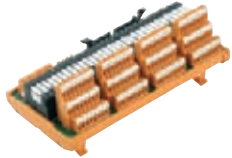

Versions with LED only for cards with nominal voltage of 24 V DC

MICROSERIES GROUP

MICROSERIES (relays)	Connection		Order No. Adapter	Order No. Input or output Relay
	Screw	Tension clamp connection		
MICRO 160 GROUP			8773600000 (x2units)	8533640000 (x16units)
			8773620000 (x2units)	8533660000 (x16units)
MICRO 320 GROUP			8773600000 (x4units)	8533640000 (x32units)
			8773620000 (x4units)	8533660000 (x32units)
MICRO 16I GROUP			8773510000 (x2units)	8596060000 (x16units)
			8773530000 (x2units)	8596080000 (x16units)
MICRO 32I GROUP			8773510000 (x4units)	8596060000 (x32units)
			8773530000 (x4units)	8596080000 (x32units)



Email: sales@cambia.com

Email: sales@cambia.a.c

FAD - Front adapters for Siemens S7-300 and Rockwell Control-Logix

FAD - Front adapters for Siemens S7-300

Front adapters for Siemens S7-300 cards with 20 and 40 poles.

- The voltage may be supplied directly to the front adapter and can be distributed in common or separately by byte (8 signals)

FAD S7/300 HE20 UNIV

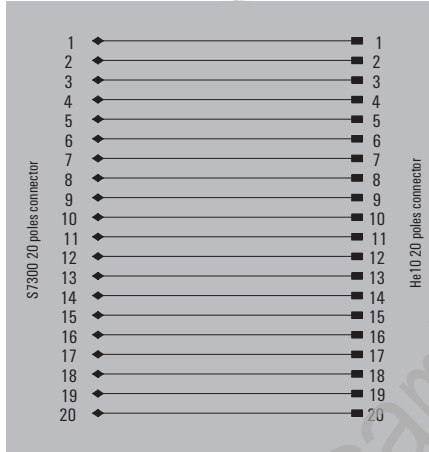

FAD S7/300 HE20 16 DIO

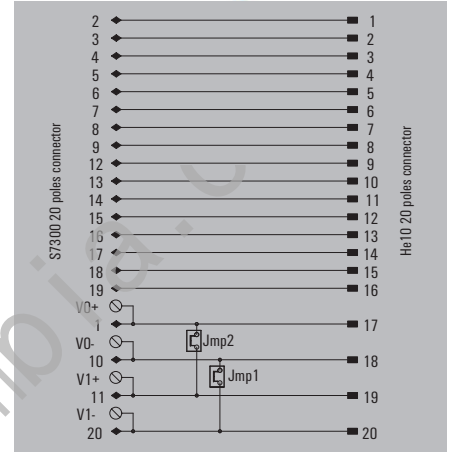

Technical data

Connection data	Siemens S7-300 card with 20-pole connector and operating voltage ≤ 30 V AC / 60 V DC	6ES7 321-1BH01-0AA0, 6ES7 321-1BH81-0AA0, 6ES7 321-1BH50-0AA0, 6ES7 321-7RD00-0AB0, 6ES7 322-1BH01-0AB0, 6ES7 322-1BH81-0AA0
Connection to the card	IEC 603-1 / DIN 41651 20p	IEC 603-1 / DIN 41651 20p
Connection (field side)		
Rated data		
Operating voltage	30 V AC / 60 V DC	30 V AC / 60 V DC
Max. current per channel	1 A	1 A
Max. current per byte		2 A
Total operating current	20 A	
General data		
Ambient temperature (operational)	-25...+50°C	-25...+50°C
Storage temperature	-40...+60 °C	-40...+60 °C
Approvals	CE	CE
Insulation coordination (EN50178)		
Rated insulation voltage	< 50 V AC	< 50 V AC
Surge voltage category	III	III
Pollution severity level	2	2
Insulation test voltage	0.35 kVAC	0.35 kVAC

Dimensions

Length x width	124 mm / 23 mm	124 mm / 23 mm
----------------	----------------	----------------

Note

Ordering data

Type	Order No.	Type	Order No.
FAD S7/300 HE20 UNIV	1127840000	FAD S7/300 HE20 16DIO	1127850000

Note

Accessories

Note		
------	--	--

FAD S7/300 HE40 UNIV

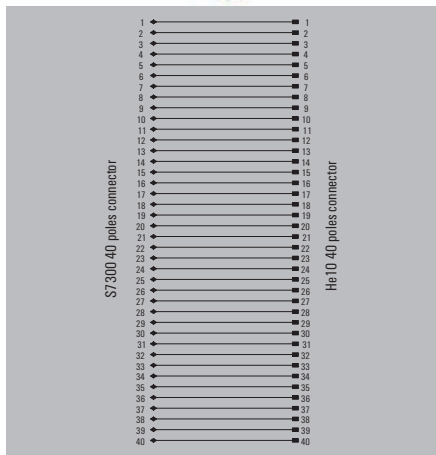

FAD S7/300 2XHE20 32DIO

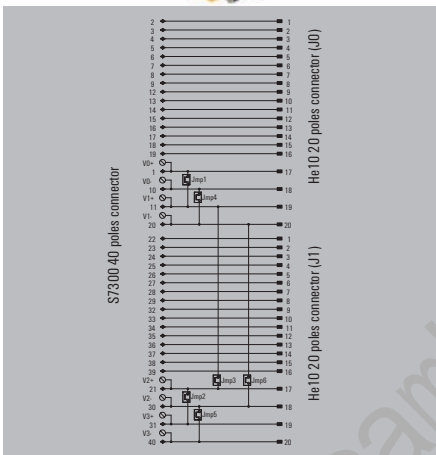

FAD S7/300 HE40 32DIO

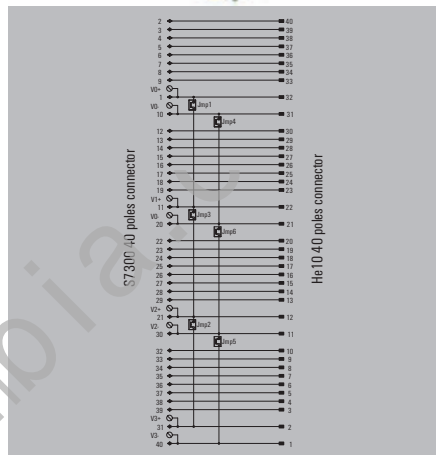

Siemens S7-300 card with 40-pole connector and operating voltage ≤ 30 V AC / 60 V DC	
Plug-in connectors according to IEC 603-1 / DIN 41651 40p	
30 V AC / 60 V DC	
1 A	
40 A	
-25...+50°C	
-40...+60 °C	
CE	
< 50 V AC	
III	
2	
0.35 kVAC	
115 mm / 21.5 mm	

6ES7 321-1BL00-0AA0, 6ES7 321-1BL80-0AB0, 6ES7 322-1BL00-0AA0	
2 x plug-in connectors according to IEC 603-1 / DIN 41651 20p	
30 V AC / 60 V DC	
1 A	
2 A	
-25...+50°C	
-40...+60 °C	
CE	
< 50 V AC	
III	
2	
0.35 kVAC	
115 mm / 21.5 mm	

6ES7 321-1BL00-0AA0, 6ES7 321-1BL80-0AB0, 6ES7 322-1BL00-0AA0	
Plug-in connectors according to IEC 603-1 / DIN 41651 40p	
30 V AC / 60 V DC	
1 A	
2 A	
-25...+50°C	
-40...+60 °C	
CE	
< 50 V AC	
III	
2	
0.35 kVAC	
115 mm / 21.5 mm	

Type	Order No.
FAD S7/300 HE40 UNIV	1127870000

Type	Order No.
FAD S7/300 2XHE20 32DIO	1127880000

Type	Order No.
FAD S7/300 HE40 32DIO	1127890000

FAD - Front adapters for Siemens S7-300 and Rockwell Control-Logix

FAD - Front adapters for Rockwell Control-Logix

Front adapters for Rockwell Control-Logix cards with 20 and 36 poles.

- The voltage may be supplied directly to the front adapter and can be distributed in common or separately by byte (8 signals)

FAD CLTX HE20 UNIV

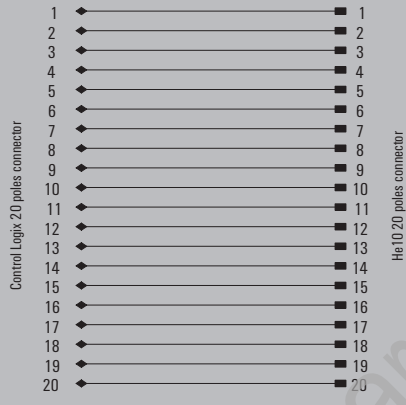

FAD CLTX HE20 16DI

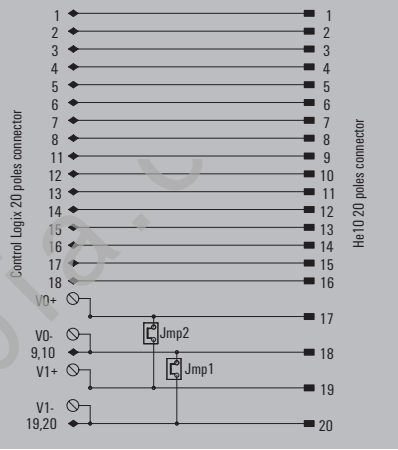

Technical data

Connection data	Control Logix card with 20-pole connector and operating voltage ≤ 30 V AC / 60 V DC	1756-IB16, 1756-IC16, 1756-IN16
Connection to the card		
Connection (field side)	IEC 603-1 / DIN 41651 20p	IEC 603-1 / DIN 41651 20p
Rated data		
Operating voltage	30 V AC / 60 V DC	30 V AC / 60 V DC
Max. current per channel	1 A	1 A
Max. current per byte		2 A
Total operating current	20 A	
General data		
Ambient temperature (operational)	-25...+50°C	-25...+50°C
Storage temperature	-40...+60 °C	-40...+60 °C
Approvals	CE	CE
Insulation coordination (EN50178)		
Rated insulation voltage	< 50 V AC	< 50 V AC
Surge voltage category	III	III
Pollution severity level	2	2
Insulation test voltage	0.35 kVAC	0.35 kVAC

Dimensions

Length x width	34.5 mm / 110 mm	34.5 mm / 110 mm
----------------	------------------	------------------

Note

Ordering data

Type	Order No.	Type	Order No.
FAD CLTX HE20 UNIV	1127900000	FAD CLTX HE20 16DI	1127910000

Note

Accessories

Note		
-------------	--	--

FAD CLTX HE20 16DO

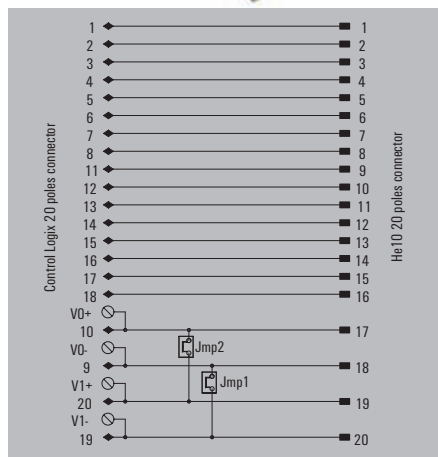

FAD CLTX HE40 UNIV

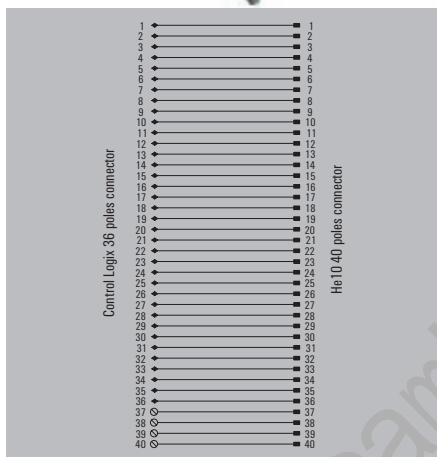

FAD CLTX 2XHE20 32DI

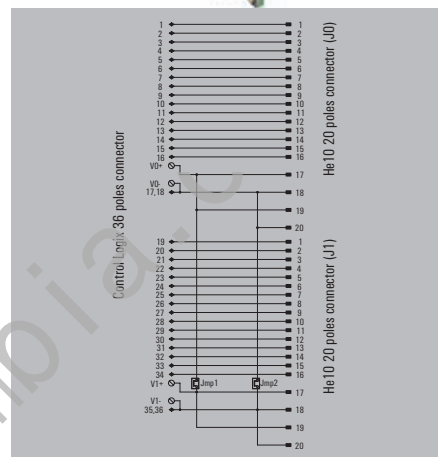

1756-0B16E, 1756-0V16E
IEC 603-1 / DIN 41651 20p
30 V AC / 60 V DC
1 A
2 A
-25...+50°C
-40...+60 °C
CE
< 50 V AC
III
2
0.35 kVAC

Control Logix card with 36-pole connector and operating voltage ≤ 30 V AC / 60 V DC
Plug-in connectors according to IEC 603-1 / DIN 41651 40p
30 V AC / 60 V DC
1 A
40 A
-25...+50°C
-40...+60 °C
CE
< 50 V AC
III
2
0.35 kVAC

1756-IB32
2 x plug-in connectors according to IEC 603-1 / DIN 41651 20p
30 V AC / 60 V DC
1 A
2 A
-25...+50°C
-40...+60 °C
CE
< 50 V AC
III
2
0.35 kVAC

34.5 mm / 110 mm

34.5 mm / 110 mm

34.5 mm / 110 mm

Type	Order No.
FAD CLTX HE20 16DO	1127950000

Type	Order No.
FAD CLTX HE40 UNIV	1127920000

Type	Order No.
FAD CLTX 2XHE20 32DI	1127930000

FAD - Front adapters for Siemens S7-300 and Rockwell Control-Logix

FAD - Front adapters for Rockwell Control-Logix

Front adapters for Rockwell Control-Logix cards with 20 and 36 poles.

- The voltage may be supplied directly to the front adapter and can be distributed in common or separately by byte (8 signals)

FAD CLTX HE40 32DI

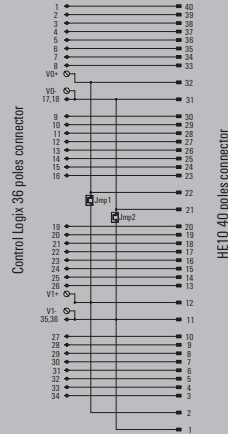

FAD CLTX 2XHE20 32DO

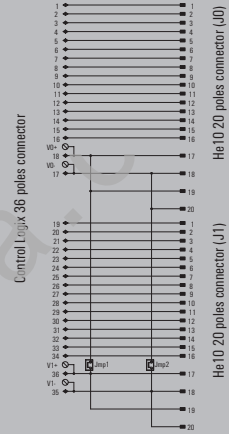

Technical data

Connection data

Connection to the card

1756-IB32

1756-OB32

Connection (field side)

Rated data

Operating voltage
Max. current per channel
Max. current per byte
Total operating current

Plug-in connectors according to IEC 603-1 / DIN 41651 40p

30 V AC / 60 V DC
1 A
2 A

2 x plug-in connectors according to IEC 603-1 / DIN 41651 20p

30 V AC / 60 V DC
1 A
2 A

General data

Ambient temperature (operational)
Storage temperature
Approvals

-25...+50 °C
-40...+60 °C
CE

-25...+50 °C
-40...+60 °C
CE

Insulation coordination (EN50178)

Rated insulation voltage
Surge voltage category
Pollution severity level
Insulation test voltage

< 50 V AC
III
2
0.35 kVAC

< 50 V AC
III
2
0.35 kVAC

Dimensions

Length x width

34.5 mm / 110 mm

34.5 mm / 110 mm

Note

Ordering data

Type	Order No.
FAD CLTX HE40 32DI	1127940000

Type	Order No.
FAD CLTX 2XHE20 32DO	1127990000

Note

Accessories

Note



FAD CLTX HE40 32DO

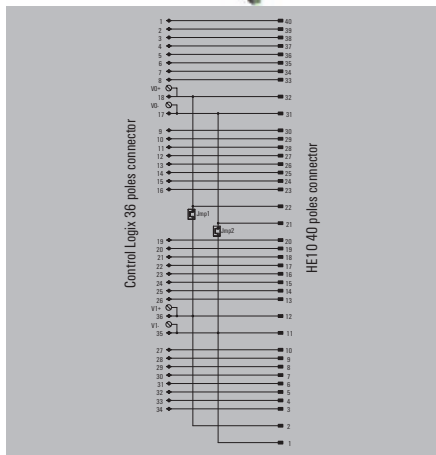

1756-0B32

Plug-in connectors according to IEC 603-1 / DIN 41651 40p

30 V AC / 60 V DC

1 A

2 A

-25...+50°C

-40...+60 °C

CE

< 50 V AC

III

2

0.35 kVAC

34.5 mm / 110 mm

Type	Order No.
FAD CLTX HE40 32DO	1127980000

RSF PLC - Passive interface for digital signals

RSF PLC-Passive interface

for 1 wire digital signals

Compact interfaces for the transmission of 32 digital input/output signals (RSF PLC)

- Signals can be grouped by byte (selected via jumpers)
- Option of switching by positive or negative signals (selected via jumpers)
- Optional status indicator (LED) showing the operating status and voltages
- Screw or tension clamp connection

RS F40 INIT32

1 wire

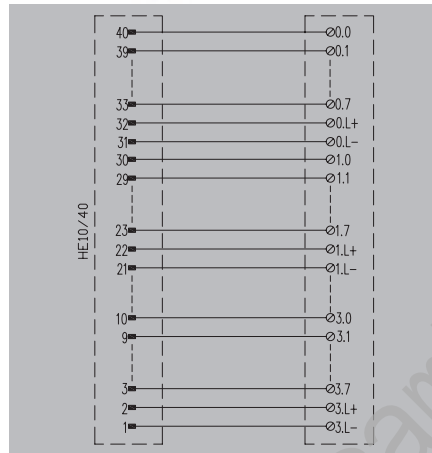
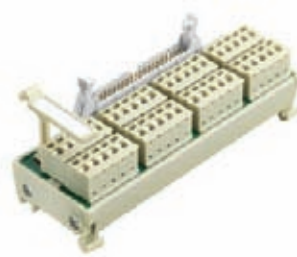

RSF PLC 1W 32IO

1 wire

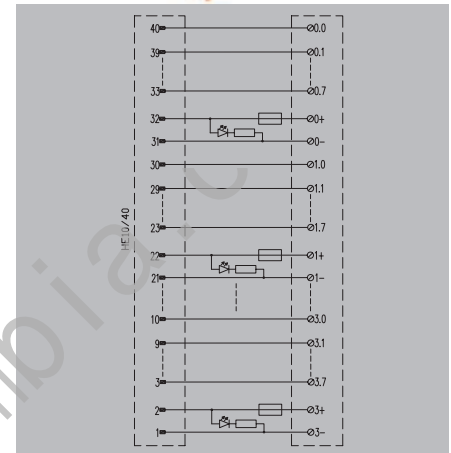

Technical data

Connection data and functionality	
Connection on control side	
Number of poles (control side)	
LED status display per channel	
LED status of the supply voltage	
Fuse per channel	
Power supply fuse	
Rated data	
Operating voltage	
Max. current per channel	
Max. current per byte	
Operating voltage (supply)	
Operating current (supply)	
General data	
Ambient temperature (operational)	
Storage temperature	
Approvals	
Insulation coordination (EN50178)	
Rated insulation voltage	
Surge voltage category	
Pollution severity level	
Insulation test voltage	
Dimensions	
Clamping range, min. /max. [Field]	
Clamping range, min. /max. [supply]	
Mounting rail	
Length x width	
Note	

Ordering data

	Screw connection without LED
	Screw connection with LED
	Tension-clamp connection without LED
	Tension-clamp connection with LED
Note	

Accessories

Note	
------	--

Plug-in connector acc. IEC 603-1 / DIN 41651		
40-pole plug		
No		
No		
No		
No		
Rated data		
50 V AC		
1 A		
General data		
0...+55°C		
-40...+70 °C		
CE; GOSTME25		
Insulation coordination		
< 50 V AC		
III		
2		
0.35 kVAC		
Tension clamp connection		
0.5 mm ² / 1.5 mm ²		
0.5 mm ² / 1.5 mm ²		
TS 35		
125 mm / 45 mm		
Note		

Type	Height	Order No.
RS F40 I/O32 LMZF	54 mm	8428880000
Note		

Plug-in connector acc. IEC 603-1 / DIN 41651		
40-pole plug		
No		
No		
No		
2.5 A		
Rated data		
30 V AC / 60 V DC		
1 A		
2 A		
24 V DC ± 10%		
4 A		
General data		
-25...+50°C		
-40...+60 °C		
CE		
Insulation coordination		
< 50 V AC		
III		
2		
0.35 kVAC		
Screw connection		Tension clamp connection
0.13 mm ² / 6 mm ²		0.13 mm ² / 2.5 mm ²
0.13 mm ² / 6 mm ²		0.13 mm ² / 2.5 mm ²
TS 32, TS 35		TS 32, TS 35
113 mm / 87 mm		113 mm / 87 mm
Note		
Factory setting: Common negative pole		

Type	Height	Order No.
RSF PLC 1W 32IO S	72 mm	1128140000
RSF PLC 1W 32IO Z	72 mm	1128150000
Note		

RSF PLC 1W 32IO LEDs

1 wire with LED

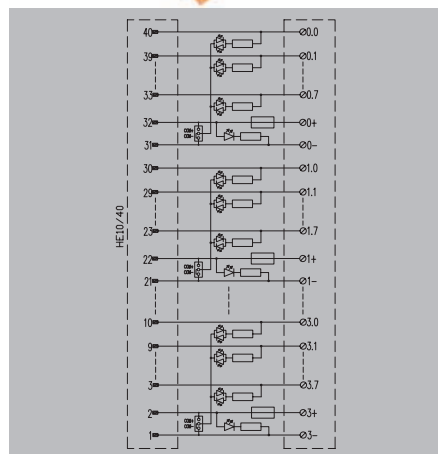

Plug-in connector acc. IEC 603-1 / DIN 41651	
40-pole plug	
Green(common negative)/Red(common positive)	
yellow	
No	
2.5 A	
24 V DC ± 10%	
1 A	
2 A	
24 V DC ± 10%	
4 A	
-25...+50°C	
-40...+60 °C	
CE	
< 50 V AC	
III	
2	
0.35 kVAC	
Screw connection	Tension clamp connection
0.13 mm ² / 6 mm ²	0.13 mm ² / 2.5 mm ²
0.13 mm ² / 6 mm ²	0.13 mm ² / 2.5 mm ²
TS 32, TS 35	TS 32, TS 35
113 mm / 87 mm	113 mm / 87 mm
Factory setting: Common negative pole	

Type	Height	Order No.
RSF PLC 1W 32IO LEDs S	72 mm	1128160000
RSF PLC 1W 32IO LEDs Z	72 mm	1128170000

RSF PLC - Passive interface for digital signals

RSF PLC - Passive Interface for 2 wire digital signals

Compact interfaces for the transmission of 32 digital input/output signals (RSF PLC)

- Signals can be grouped by byte (selected via jumpers)
- Option of switching by positive or negative signals (selected via jumpers)
- Optional status indicator (LED) showing the operating status and voltages
- Screw or tension clamp connection

RSF PLC 2W 32IO

2 wires

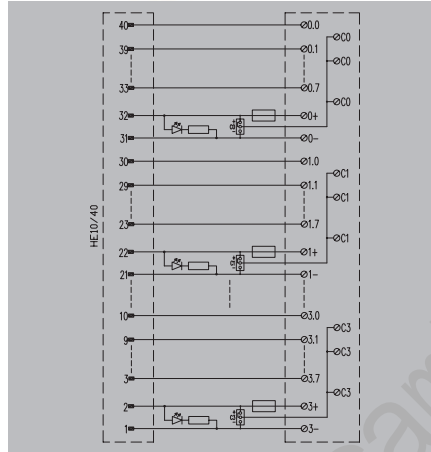
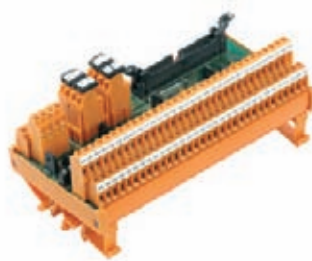

RSF PLC 2W 32IO LEDS

2 wires with LED

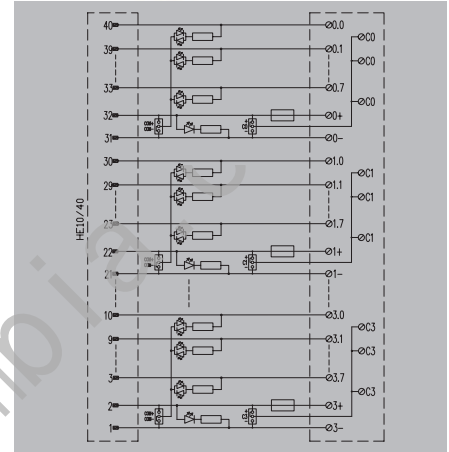

Technical data

Connection data and functionality	
Connection on control side	
Number of poles (control side)	
LED status display per channel	
LED status of the supply voltage	
Fuse per channel	
Power supply fuse	
Rated data	
Operating voltage	
Max. current per channel	
Max. current per byte	
Operating voltage (supply)	
Operating current (supply)	
General data	
Ambient temperature (operational)	
Storage temperature	
Approvals	
Insulation coordination (EN50178)	
Rated insulation voltage	
Surge voltage category	
Pollution severity level	
Insulation test voltage	
Dimensions	
Clamping range, min. /max. [Field]	
Clamping range, min. /max. [supply]	
Mounting rail	
Length x width	
Note	

Ordering data

	Screw connection without LED
	Screw connection with LED
	Tension-clamp connection without LED
	Tension-clamp connection with LED
Note	

Accessories

Note	
------	--

Plug-in connector acc. IEC 603-1 / DIN 41651	
40-pole plug	
No	
yellow	
No	
2.5 A	
30 V AC / 60 V DC	
1 A	
2 A	
24 V DC ± 10%	
4 A	
-25...+50°C	
-40...+60 °C	
CE	
< 50 V AC	
III	
2	
0.35 kVAC	
Screw connection	Tension clamp connection
0.13 mm ² / 6 mm ²	0.13 mm ² / 2.5 mm ²
0.13 mm ² / 6 mm ²	0.13 mm ² / 2.5 mm ²
TS 32, TS 35	TS 32, TS 35
170 mm / 87 mm	170 mm / 87 mm
Factory setting: Common negative pole	

Type	Height	Order No.
RSF PLC 2W 32IO S	72 mm	1128180000
RSF PLC 2W 32IO Z	72 mm	1128190000

Plug-in connector acc. IEC 603-1 / DIN 41651	
40-pole plug	
Green(common negative)/Red(common positive)	
yellow	
No	
2.5 A	
24 V DC ± 10%	
1 A	
2 A	
24 V DC ± 10%	
4 A	
-25...+50°C	
-40...+60 °C	
CE	
< 50 V AC	
III	
2	
0.35 kVAC	
Screw connection	Tension clamp connection
0.13 mm ² / 6 mm ²	0.13 mm ² / 2.5 mm ²
0.13 mm ² / 6 mm ²	0.13 mm ² / 2.5 mm ²
TS 32, TS 35	TS 32, TS 35
170 mm / 87 mm	170 mm / 87 mm
Factory setting: Common negative pole	

Type	Height	Order No.
RSF PLC 2W 32IO LEDS S	72 mm	1128200000
RSF PLC 2W 32IO LEDS Z	72 mm	1128210000

RSF PLC 2W 32IO FUS

2 wires with LED with and fuses per channel

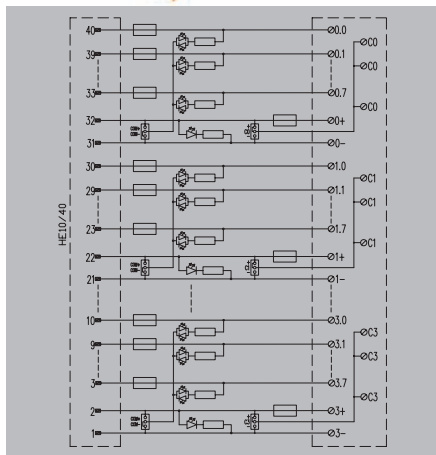
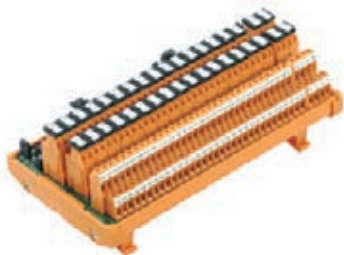

Plug-in connector acc. IEC 603-1 / DIN 41651	
40-pole plug	
Green(common negative)/Red(common positive)	
yellow	
500 mA	
2.5 A	
24 V DC ± 10%	
1 A	
2 A	
24 V DC ± 10%	
4 A	
-25...+50°C	
-40...+60 °C	
< 50 V AC	
III	
2	
0.35 kVAC	
Screw connection	Tension clamp connection
0.13 mm ² / 6 mm ²	0.13 mm ² / 2.5 mm ²
0.13 mm ² / 6 mm ²	0.13 mm ² / 2.5 mm ²
TS 32, TS 35	TS 32, TS 35
200 mm / 109 mm	200 mm / 109 mm
Factory setting: Common negative pole	

Type	Height	Order No.
RSF PLC 2W 32IO FUS S	72 mm	1128240000
RSF PLC 2W 32IO FUS Z	72 mm	1128250000

RSF PLC - Passive interface for digital signals

RSF PLC - Passive interface for 3 wire digital signals

Compact interfaces for the transmission of 32 digital input/output signals (RSF PLC)

- Signals can be grouped by byte (selected via jumpers)
- Optional status indicator (LED)

RSF F40 INIT32 LMZF

3 wires

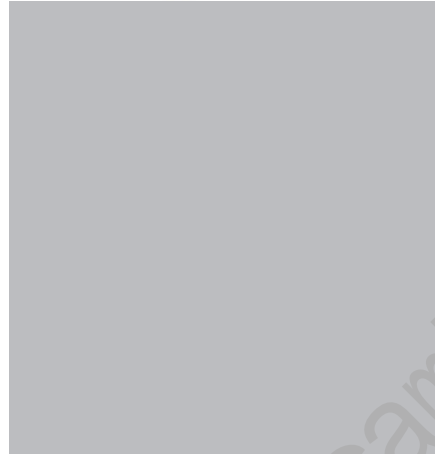
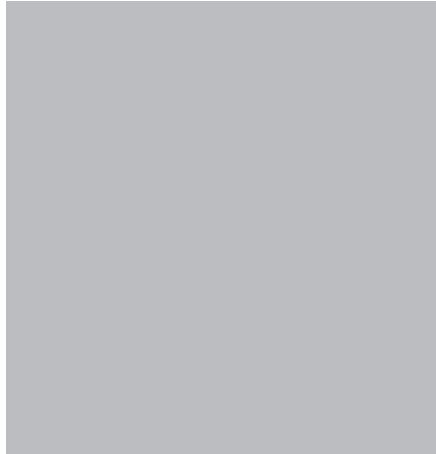
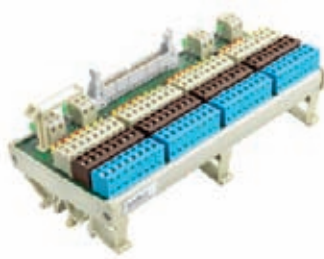

Technical data

Connection data and functionality	
Connection on control side	
Number of poles (control side)	
LED status display per channel	
LED status of the supply voltage	
Fuse per channel	
Power supply fuse	
Rated data	
Operating voltage	50 V AC
Max. current per channel	1 A
Max. current per byte	
Operating voltage (supply)	24 V DC ± 10%
Operating current (supply)	
General data	
Ambient temperature (operational)	-25...+50 °C
Storage temperature	-40...+60 °C
Approvals	CE, GOSTME25
Insulation coordination (EN50178)	
Rated insulation voltage	< 50 V AC
Surge voltage category	III
Pollution severity level	2
Insulation test voltage	0.35 kVAC
Dimensions	
Clamping range, min. /max. [Field]	0.15 mm ² / 1.5 mm ²
Clamping range, min. /max. [supply]	0.15 mm ² / 1.5 mm ²
Mounting rail	TS 32, TS 35
Length x width	185 mm / 87 mm
Note	
Factory setting: Common negative pole	

Ordering data

Tension-clamp connection without LED	Type	Height	Order No.
Tension-clamp connection with LED	RS F40 INIT32 LMZF	73 mm	8430980000

Note

Accessories

Note

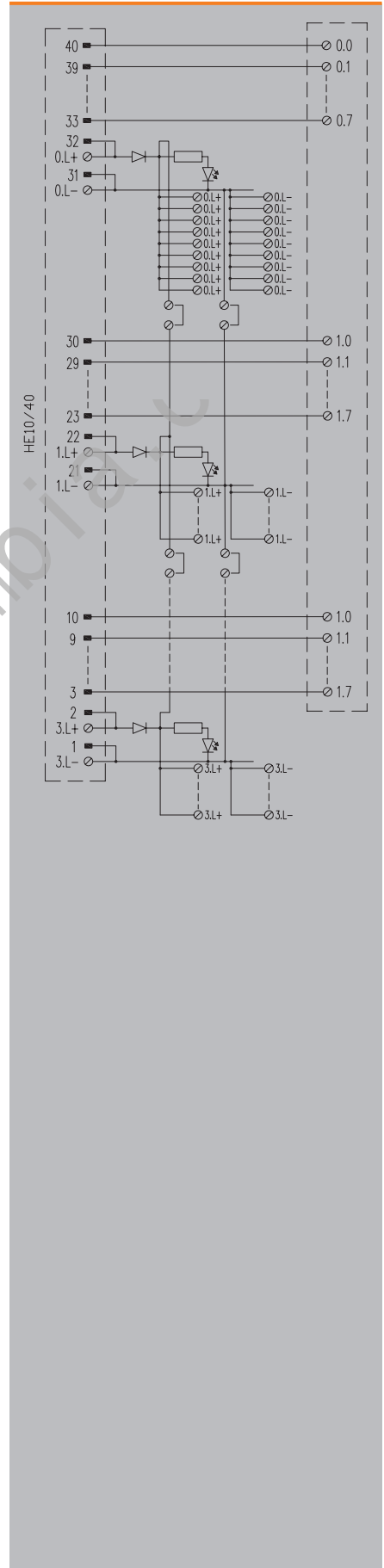

**RSF PLC - Passive interface
for 3 wire digital signals**

Compact interfaces for the transmission of 32 digital input/output signals (RSF PLC)

- Signals can be grouped by byte (selected via jumpers)
- Optional status indicator (LED)

RSF F40 INIT32 LD

3 wires with LED

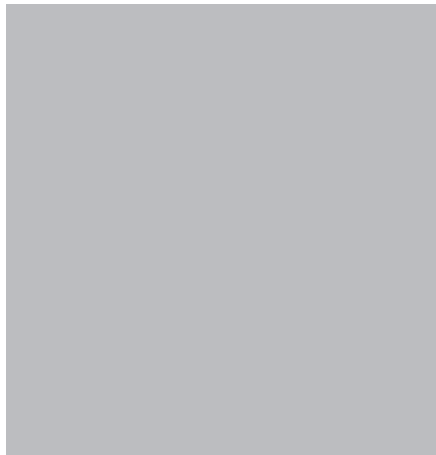
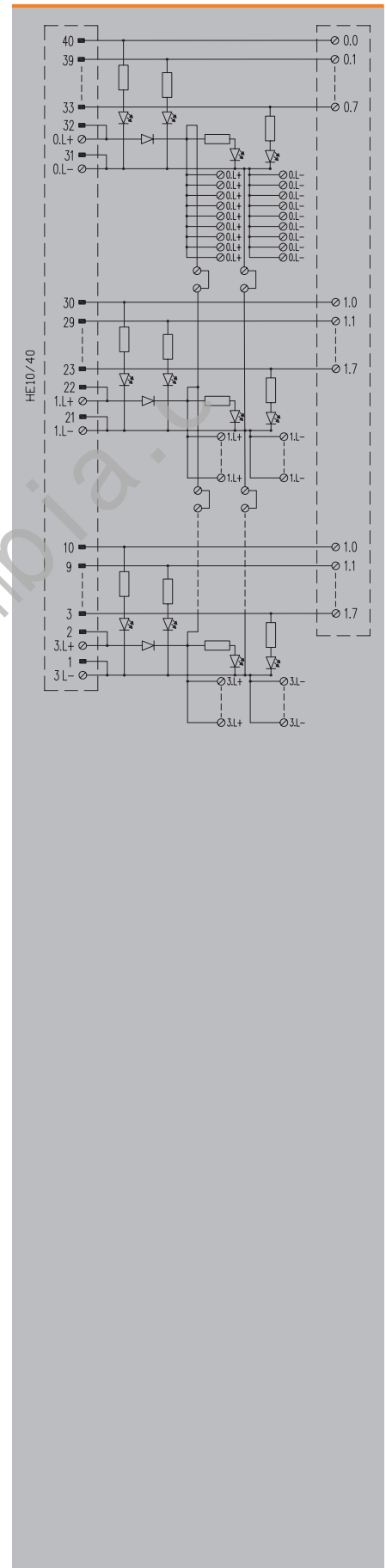
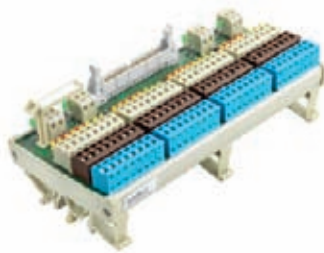

Technical data

Connection data and functionality	
Connection on control side	
Number of poles (control side)	
LED status display per channel	
LED status of the supply voltage	
Fuse per channel	
Power supply fuse	
Rated data	
Operating voltage	24 V DC ± 10%
Max. current per channel	1 A
Max. current per byte	
Operating voltage (supply)	24 V DC ± 10%
Operating current (supply)	
General data	
Ambient temperature (operational)	-25...+50 °C
Storage temperature	-40...+60 °C
Approvals	CE, GOSTME25
Insulation coordination (EN50178)	
Rated insulation voltage	< 50 V AC
Surge voltage category	III
Pollution severity level	2
Insulation test voltage	0.35 kVAC
Dimensions	
Clamping range, min. /max. [Field]	0.15 mm ² / 1.5 mm ²
Clamping range, min. /max. [supply]	0.15 mm ² / 1.5 mm ²
Mounting rail	TS 32, TS 35
Length x width	185 mm / 87 mm
Note	
Factory setting: Common negative pole	

Type		
Type	Height	Order No.
RS F40 INIT32 LD LMZF	73 mm	8428900000

Ordering data

Tension-clamp connection without LED
Tension-clamp connection with LED

Note

Accessories

Note

RSM - Isolated interfaces for digital signals

**RSM - Interfaces
for 16 isolated digital signals**

Relay digital output interface for transmitting electrical signals between the PLC and field via SIM cables or front adapters FAD.

- Electrical insulation using pluggable relays (interchangeable with solid-state relays)
- Status indicator (LED)
- Screw or tension clamp connection

RSF40 16 RS OUT

RCL relay with 1 CO contact

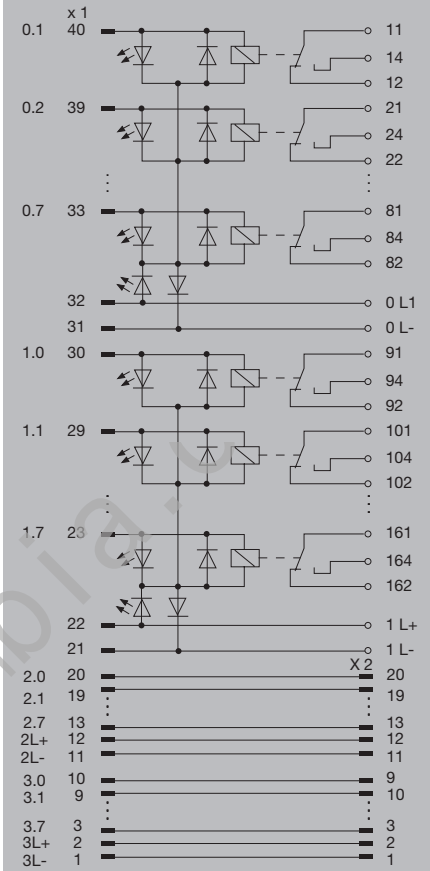

Technical data

Connection data and functionality

Connection on control side
 Number of poles (control side)
 Relay type
 LED status display per relay
 LED status of the supply voltage
 Fuse per relay
 Power supply fuse

Nominal input data

Input voltage
 Input current
 Operating voltage (supply)

Nominal output data

Contact material
 Operating voltage
 Max. AC continuous current
 Minimum contact current
 Minimum contact voltage
 Mechanical service life

General data

Ambient temperature (operational)
 Storage temperature
 Approvals

Insulation coordination (EN50178)

Rated input insulation voltage
 Rated output insulation voltage
 Overvoltage category input/output
 Pollution severity level
 Pulse voltage test (1,2/50µs)
 Insulation test voltage
 Clearance input/output

Dimensions

Clamping range, min. /max. [Field]
 Clamping range, min. /max. [supply]
 Mounting rail
 Length x width

Note

Ordering data

Screw connection without switch

Note

Accessories

Note

Technical data

Plug-in connector acc. IEC 603-1 / DIN 41651
 40-pole plug
 RCL314024
 yellow
 green
 No
 No

24 V DC ± 10%
 30 mA
 24 V DC ± 10%

AgNi 90/10
 250 V AC
 6 A
 0.01 A
 12 V
 3 x 10⁷ switching cycles

0...+55°C
 -40...+70 °C
 CE, GOSTME25

< 50 V AC
 < 250 V AC
 III
 2
 6 kV
 4.4 kVAC
 ≥ 5.5 mm

Screw connection

0.13 mm² / 6 mm²
 0.13 mm² / 6 mm²
 TS 32, TS 35
 350 mm / 87 mm

Expansion module: 8224191001 (20 pole cable included)

Type	Height	Order No.
RS F40 16RS OUT 24VDC	76 mm	8224181001

8693260000 RCL314024 24 V DC 1CO

RSM - Interfaces
for 32 isolated digital signals

Relay digital output interface for transmitting electrical signals between the PLC and field via SIM cables or front adapters FAD.

- Input/output reinforced insulation (basic between contacts)
- Status indicator (LED)
- Screw or tension clamp connection

RSM-32 PLC C 1CO

6 mm relay with 1 CO contact and switch

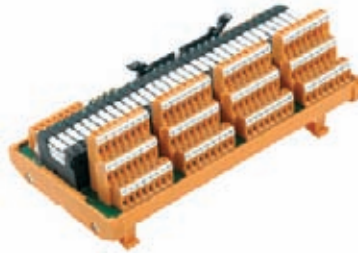

Technical data

Connection data and functionality	
Connection on control side	
Number of poles (control side)	
Relay type	
LED status display per relay	
LED status of the supply voltage	
Fuse per relay	
Power supply fuse	
Nominal input data	
Input voltage	
Input current	
Operating voltage (supply)	
Operating current (supply)	
Nominal output data	
Contact material	
Operating voltage	
Max. AC continuous current	
Minimum contact current	
Minimum contact voltage	
Mechanical service life	
General data	
Ambient temperature (operational)	
Storage temperature	
Approvals	
Insulation coordination (EN50178)	
Rated input insulation voltage	
Rated output insulation voltage	
Overvoltage category input/output	
Overvoltage category output/output	
Pollution severity level	
Pulse voltage test (1,2/50µs)	
Insulation test voltage	
Clearance input/output	
Dimensions	
Clamping range, min. /max. [Field]	
Clamping range, min. /max. [supply]	
Mounting rail	
Length x width	
Note	

Plug-in connector acc. IEC 603-1 / DIN 41651			
40-pole plug			
RSS			
green			
yellow			
No			
No			
24 V DC ± 10%			
13 mA			
24 V DC ± 10%			
2 A			
AgNi 90/10			
250 V AC			
2.5 A			
0.1 A			
5 V			
5 x 10 ⁶ switching cycles			
-25...+50 °C			
-40...+60 °C			
CE			
< 50 V AC			
250 V AC			
III			
II			
2			
6 kV			
1.2 kVAC			
≥ 5.5 mm			
Screw connection		Tension clamp connection	
0.13 mm ² / 6 mm ²		0.13 mm ² / 2.5 mm ²	
0.13 mm ² / 6 mm ²		0.13 mm ² / 2.5 mm ²	
TS 32, TS 35		TS 32, TS 35	
215 mm / 109 mm		255 mm / 109 mm	

Ordering data

Screw connection without switch	
Screw connection with switch	
Tension-clamp connection without switch	
Tension-clamp connection with switch	
Note	

Type	Height	Order No.
RSM-32 PLC C 1CO S	85 mm	1129050000
RSM-32 PLC C SW 1CO S	85 mm	1129080000
RSM-32 PLC C 1CO Z	85 mm	1129070000
RSM-32 PLC C SW 1CO Z	85 mm	1129090000

Accessories

Note	
------	--

Relay 4060120000 RSS 24 V DC 1CO

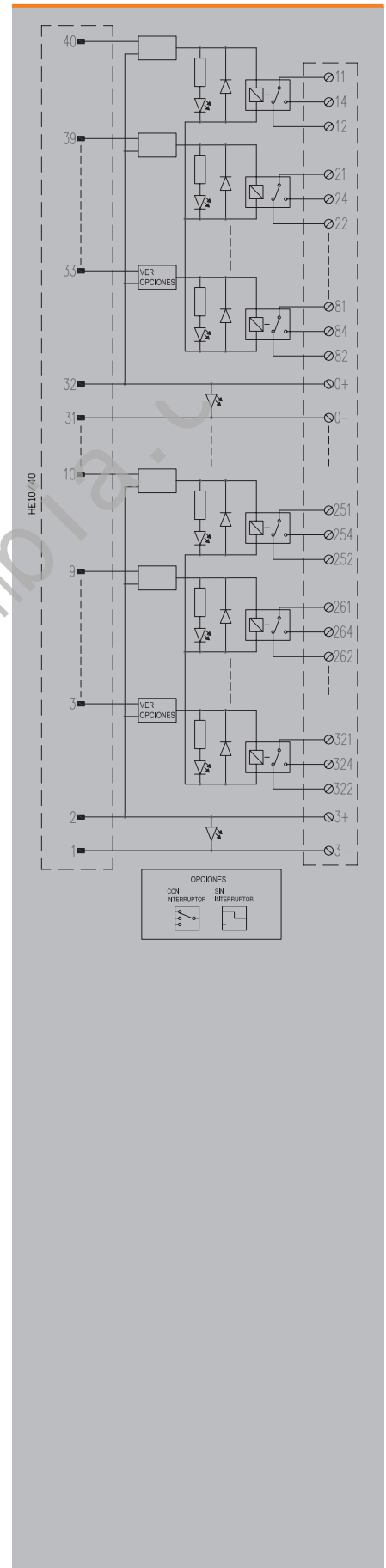

RSM - Isolated interfaces for digital signals

**RSM - Interfaces
for 32 isolated digital signals**

Relay digital output interface for transmitting electrical signals between the PLC and field via SIM cables or front adapters FAD.

- Input/output reinforced insulation (basic between contacts)
- Status indicator (LED)
- Screw or tension clamp connection



Technical data

Connection data and functionality

Connection on control side
 Number of poles (control side)
 Relay type
 LED status display per relay
 LED status of the supply voltage
 Fuse per relay
 Power supply fuse

Nominal input data

Input voltage
 Input current
 Operating voltage (supply)
 Operating current (supply)

Nominal output data

Contact material
 Operating voltage
 Max. AC continuous current
 Minimum contact current
 Minimum contact voltage
 Mechanical service life

General data

Ambient temperature (operational)
 Storage temperature
 Approvals

Insulation coordination (EN50178)

Rated input insulation voltage
 Rated output insulation voltage
 Overvoltage category input/output
 Overvoltage category output/output
 Pollution severity level
 Pulse voltage test (1,2/50µs)
 Insulation test voltage
 Clearance input/output

Dimensions

Clamping range, min. /max. [Field]
 Clamping range, min. /max. [supply]
 Mounting rail
 Length x width

Note

Ordering data

- Screw connection without switch
- Screw connection with switch
- Tension-clamp connection without switch
- Tension-clamp connection with switch

Note

Accessories

Note

RSM-32 PLC 1CO S

6 mm relay with 1 CO contact and switch

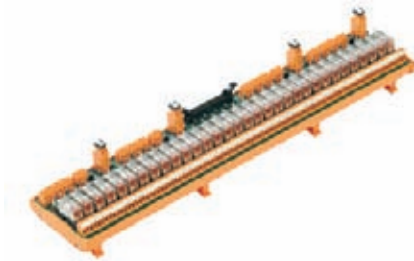

Plug-in connector acc. IEC 603-1 / DIN 41651	
40-pole plug	
RCL	
green	
yellow	
No	
2.5 A	
24 V UC ± 10%	
17 mA	
24 V DC ± 10%	
2.5 A	
AgNi 90/10	
250 V AC	
6 A	
0.01 A	
12 V	
3 x 10 ⁶ switching cycles	
-25...+50 °C	
-40...+60 °C	
CE	
< 50 V AC	
250 V AC	
III	
II	
2	
6 kV	
2.5 kVAC	
≥ 5.5 mm	
Screw connection	Tension clamp connection
0.13 mm ² / 6 mm ²	0.13 mm ² / 2.5 mm ²
0.13 mm ² / 6 mm ²	0.13 mm ² / 2.5 mm ²
TS 32, TS 35	TS 32, TS 35
497 mm / 109 mm	497 mm / 109 mm

Type	Height	Order No.
RSM-32 PLC 1CO S	68 mm	1129140000
RSM-32 PLC SW 1CO S	68 mm	1129170000
RSM-32 PLC 1CO Z	68 mm	1129150000
RSM-32 PLC SW 1CO Z	68 mm	1129180000

Relay 8693260000 RCL314024 24 V DC 1CO

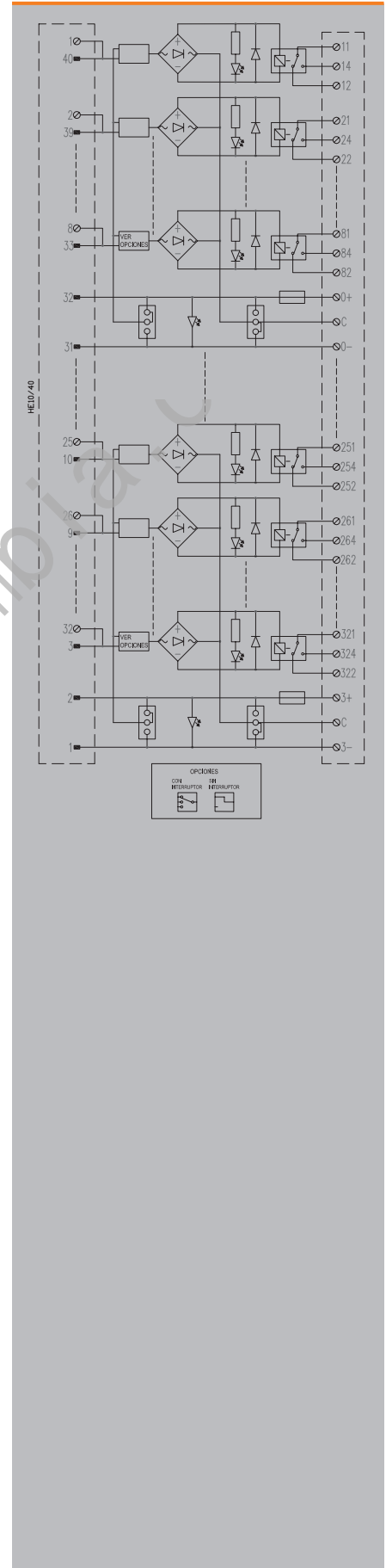

Email: sales@cambia.a.c

MICRO-INTERFACE: Solutions for PLC with relays and optos from the MICROSERIES family

The MICRO-PLC adapter is used to connect the MICROSERIES family relays and opto modules to the PLC or other controllers using pre-assembled cables.

B

The adapter is formed using a 15 pole SUB-D connector or a 10 pole ribbon cable, and can be connected to a group of 8 MICROSERIES relays/opto modules, either with screw or tension clamp connection.

MICRO-INTERFACE module for ribbon cable connection



MICRO-INTERFACE module for SUB-D connection



To help you to choose the right products for your application, Weidmüller offers selection tables in this catalogue that enable you to choose a set comprising pre-assembled cable + adapter + microrelay/optomodule, depending on the PLC card.

Instructions for assembling the adapter



Assemble a block of 8 MICROSERIES on the rail and adjust the ends

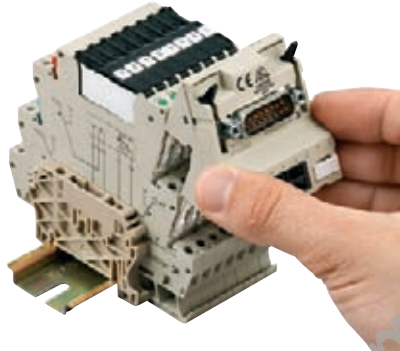

Insert the adapter onto the cross-connection rail and make sure that it is in the correct position

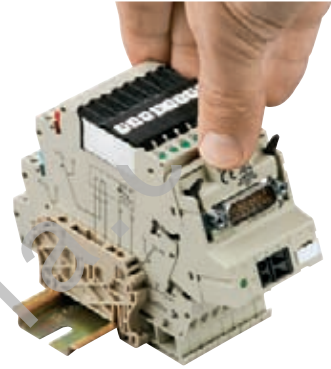

Press on the centre of the adapter from above

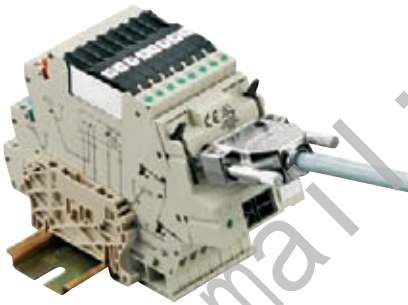

Connect the pre-assembled cable fitted with a HE-10 or SUB-D connector























To remove the cable, move the two retaining clips apart

B

PLC GEFANUC – 90-30

B

























	PLC		Cables		Connection		MICROADAPTER					
	Input/Output cards		Standard		Screw	Tension clamp	Adapter + relay					
	Manufacturer code	Number/Type of channels	Order No.	Quantity			Adapter			Inputs or outputs with relay		
							Order No.	Quantity	Page	Order No.	Quantity	Page
DI	IC693MDL241	16 DI	7789686xxx	1			8773510000	2	B.46	8596060000	16	B.51
							8773530000			8596080000		
	IC693MDL634	8 DI	7789687xxx	1			8773510000	1	B.46	8596060000	8	B.51
							8773530000			8596080000		
	IC693MDL646	16 DI	7789686xxx	1			8773510000	2	B.46	8596060000	16	B.51
						8773530000			8596080000			
	IC693MDL654	32 DI	7789688xxx	2			8773510000	4	B.46	8596060000	32	B.51
						8773530000			8596080000			
	IC693MDL655	32 DI	7789688xxx	2			8773510000	4	B.46	8596060000	32	B.51
						8773530000			8596080000			
DO	IC693MDL730	8 DO	7789689xxx	1			8773600000	1	B.47	8533640000	8	B.49
							8773620000			8533660000		
	IC693MDL732	8 DO	7789692xxx	1			8773600000	1	B.47	8533640000	8	B.49
							8773620000			8533660000		
	IC693MDL740	16 DO	7789690xxx	1			8773600000	2	B.47	8533640000	16	B.49
						8773620000			8533660000			
	IC693MDL742	16 DO	7789690xxx	1			8773600000	2	B.47	8533640000	16	B.49
						8773620000			8533660000			
	IC693MDL753	32 DO	7789691xxx	2			8773600000	4	B.47	8533640000	32	B.49
						8773620000			8533660000			

Note

- The cards should be used in positive logic.
- The adapters should receive power from an external supply.
- The last 3 digits of the cable code indicate its length in decimetres. For example, if the code ends in 100, the cable would be 10 m long.
- The relays indicated in the table are 24 V DC for the digital input cards. These relays can be replaced by MICROSERIES relays with other voltages, from 5 V DC to 230 V AC.

Email: sales@...

PLC GEFANUC – RX3i

	PLC		Cables		Connection		MICROADAPTER					
	Input/Output cards		Standard		Screw	Tension clamp	Adapter + relay					
	Manufacturer code	Number/Type of channels	Order No.	Quantity			Adapter			Inputs or outputs with relay		
					Order No.	Quantity	Page	Order No.	Quantity	Page		
DI	IC694MDL241	16 DI	7789686xxx	1			8773510000	2	B.46	8596060000	16	B.51
							8773530000			8596080000		
	IC694MDL634	8 DI	7789687xxx	1			8773510000	1	B.46	8596060000	8	B.51
							8773530000			8596080000		
	IC693MDL645	16 DI	7789686xxx	1			8773510000	2	B.46	8596060000	16	B.51
							8773530000			8596080000		
	IC693MDL646	16 DI	7789686xxx	1			8773510000	2	B.46	8596060000	16	B.51
							8773530000			8596080000		
	IC693MDL654	32 DI	7789688xxx	2			8773510000	4	B.46	8596060000	32	B.51
						8773530000			8596080000			
	IC693MDL655	32 DI	7789688xxx	2			8773510000	4	B.46	8596060000	32	B.51
						8773530000			8596080000			
	IC693MDL660	32 DI	7789693xxx	1			8773510000	4	B.46	8596060000	32	B.51
						8773530000			8596080000			
DO	IC693MDL732	8 DO	7789692xxx	1			8773620000	1	B.47	8533640000	8	B.49
							8773600000			8533660000		
	IC693MDL740	16 DO	7789690xxx	1			8773620000	2	B.47	8533640000	16	B.49
							8773600000			8533660000		
	IC693MDL742	16 DO	7789690xxx	1			8773620000	2	B.47	8533640000	16	B.49
							8773600000			8533660000		
	IC693MDL753	32 DO	7789691xxx	2			8773620000	4	B.47	8533640000	32	B.49
						8773600000			8533660000			
	IC693MDL754	32 DO	7789694xxx	1			8773620000	4	B.47	8533640000	32	B.49
						8773600000			8533660000			















Note

- The cards should be used in positive logic.
- The adapters should receive power from an external supply.
- The last 3 digits of the cable code indicate its length in decimetres. For example, if the code ends in 100, the cable would be 10 m long.
- The relays indicated in the table are 24 V DC for the digital input cards. These relays can be replaced by MICROSERIES relays with other voltages, from 5 V DC to 230 V AC.

B

PLC OMRON – CJ1W

B





















	PLC		Cables		Connection		MICROADAPTER					
	Input/Output cards		Standard		Screw	Tension clamp	Adapter + relay					
	Manufacturer code	Number/Type of channels	Order No.	Quantity			Adapter			Inputs or outputs with relay		
							Order No.	Quantity	Page	Order No.	Quantity	Page
DI	ID231	32 DI	7789758xxx	1			8773510000	4	B.46	8596060000	32	B.51
							8773530000			8596080000		
	ID232	32 DI	7789749xxx	1			8773510000	4	B.46	8596060000	32	B.51
							8773530000			8596080000		
	ID233	32 DI	7789758xxx	1			8773510000	4	B.46	8596060000	32	B.51
							8773530000			8596080000		
ID261	64 DI	7789758xxx	2			8773510000	8	B.46	8596060000	64	B.51	
						8773530000			8596080000			
ID262	64 DI	7789749xxx	2			8773510000	8	B.46	8596060000	64	B.51	
						8773530000			8596080000			
DI	OD232	32 DO	7789755xxx	1			8773600000	4	B.47	8533640000	32	B.49
							8773620000			8533660000		
	OD262	32 DO	7789755xxx	2			8773600000	8	B.47	8533640000	64	B.49
						8773620000	8533660000					

Note

- The cards should be used in positive logic.
- The adapters should receive power from an external supply.
- The last 3 digits of the cable code indicate its length in decimetres. For example, if the code ends in 100, the cable would be 10 m long.
- The relays indicated in the table are 24 V DC for the digital input cards. These relays can be replaced by MICROSERIES relays with other voltages, from 5 V DC to 230 V AC.

Email: sales@cambia

PLC ROCKWELL – COMPACT LOGIX

	PLC		Cables		Connection		MICROADAPTER					
	Input/Output cards		Standard		Screw	Tension clamp	Adapter + relay					
	Manufacturer code	Number/Type of channels	Order No.	Quantity			Adapter			Inputs or outputs with relay		
							Order No.	Quantity	Page	Order No.	Quantity	Page
DI	1769-IQ16	16 DI	1340040xxx	1			8773510000	2	B.46	8596060000	16	B.51
							8773530000			8596080000		
	1769-IQ16F	16 DI	1340040xxx	1			8773510000	2	B.46	8596060000	16	B.51
							8773530000			8596080000		
	1769-IQ32	32 DI	1340040xxx	1			8773510000	4	B.46	8596060000	16	B.51
						8773530000			8596080000			
	1769-IQ32T	32 DI	1340050xxx	1			8773510000	4	B.46	8596060000	16	B.51
							8773530000			8596080000		
DO	1769-OB8	8 DO	1340070xxx	1			8773600000	1	B.47	8533640000	8	B.49
							8773620000			8533660000		
	1769-OB16	16 DO	1340080xxx	1			8773600000	2	B.47	8533640000	16	B.49
							8773620000			8533660000		
	1769-OB16P	16 DO	1340080xxx	1			8773600000	2	B.47	8533640000	16	B.49
							8773620000			8533660000		
	1769-OB32	32 DO	1340080xxx	1			8773600000	4	B.47	8533640000	32	B.49
			1340090xxx	1			8773620000			8533660000		
	1769-OB32T	32 DO	7789799xxx	1			8773600000	4	B.47	8533640000	32	B.49
							8773620000			8533660000		





















Note

- The cards should be used in positive logic.
- The adapters should receive power from an external supply.
- The last 3 digits of the cable code indicate its length in decimetres. For example, if the code ends in 100, the cable would be 10 m long.
- The relays indicated in the table are 24 V DC for the digital input cards. These relays can be replaced by MICROSERIES relays with other voltages, from 5 V DC to 230 V AC.

B

PLC ROCKWELL – CONTROL LOGIX

B

	PLC		Cables		Connection		MICROADAPTER					
	Input/Output cards		Standard		Screw	Tension clamp	Adapter + relay					
	Manufacturer code	Number/Type of channels	Order No.	Quantity			Adapter			Inputs or outputs with relay		
					Order No.	Quantity	Page	Order No.	Quantity	Page		
DI	1756-IB16	16 DI	7789783xxx	1			8773510000	2	B.46	8596060000	16	B.51
							8773530000			8596080000		
	1756-IB16D	16 DI	7789782xxx	1			8773510000	2	B.46	8596060000	16	B.51
							8773530000			8596080000		
1756-IB16I	16 DI	7789782xxx	1			8773510000	2	B.46	8596060000	16	B.51	
						8773530000			8596080000			
1756-IB32	32 DI	7789784xxx	1			8773510000	4	B.46	8596060000	32	B.51	
						8773530000			8596080000			
DO	1756-OB16D	16 DO	7789785xxx	1			8773600000	2	B.47	8533640000	16	B.49
							8773620000			8533660000		
	1756-OB16E	16 DO	7789786xxx	1			8773600000	2	B.47	8533640000	16	B.49
							8773620000			8533660000		
	1756-OB16I	16 DO	7789787xxx	1			8773600000	2	B.47	8533640000	16	B.49
							8773620000			8533660000		
	1756-OB32	32 DO	7789766xxx	1			8773600000	4	B.47	8533640000	32	B.49
						8773620000	8533660000					
1756-OB8	8 DO	7789788xxx	1			8773600000	1	B.47	8533640000	8	B.49	
						8773620000			8533660000			
1756-OB8EI	8 DO	7789789xxx	1			8773600000	1	B.47	8533640000	8	B.49	
						8773620000			8533660000			

























Note

- The cards should be used in positive logic.
- The adapters should receive power from an external supply.
- The last 3 digits of the cable code indicate its length in decimetres. For example, if the code ends in 100, the cable would be 10 m long.
- The relays indicated in the table are 24 V DC for the digital input cards. These relays can be replaced by MICROSERIES relays with other voltages, from 5 V DC to 230 V AC.

Email: sales@cal.com



PLC SCHNEIDER – M340















	PLC		Cables		Connection		MICROADAPTER					
	Input/Output cards		Standard		Screw	Tension clamp	Adapter + relay					
	Manufacturer code	Number/Type of channels	Order No.	Quantity			Adapter			Inputs or outputs with relay		
					Order No.	Quantity	Page	Order No.	Quantity	Page		
DI	BMX DDI 1602	16 DI	7789736xxx	1			8773510000	2	B.46	8596060000	16	B.51
							8773530000			8596080000		
	BMX DDI 3202K	32 DI	7789735xxx	1			8773510000	4	B.46	8596060000	32	B.51
							8773530000			8596080000		
	BMX DDI 6402K	64 DI	7789735xxx	2			8773510000	8	B.46	8596060000	64	B.51
							8773530000			8596080000		
DO	BMX DDO 1602	16 DO	7789736xxx	1			8773600000	2	B.47	8533640000	16	B.49
							8773620000			8533660000		
	BMX DDO 3202K	32 DO	7789735xxx	1			8773600000	4	B.47	8533640000	32	B.49
							8773620000			8533660000		
	BMX DDO 6402K	64 DO	7789735xxx	2			8773600000	8	B.47	8533640000	64	B.49
							8773620000			8533660000		
DI/DO	BMX DDM 16022	8 DI	7789737xxx	1			8773510000	1	B.46	8596060000	8	B.51
							8773530000			8596080000		
	8 DO					8773600000	1	B.47	8533640000	8	B.49	
						8773620000			8533660000			
	BMX DDM 3202K	16 DI	7789735xxx	1			8773510000	2	B.46	8596060000	16	B.51
									8773530000			8596080000
	16 DO					8773600000	2	B.47	8533640000	16	B.49	
						8773620000			8533660000			

Note

- The cards should be used in positive logic.
- The adapters should receive power from an external supply.
- The last 3 digits of the cable code indicate its length in decimetres. For example, if the code ends in 100, the cable would be 10 m long.
- The relays indicated in the table are 24 V DC for the digital input cards. These relays can be replaced by MICROSERIES relays with other voltages, from 5 V DC to 230 V AC.

PLC SCHNEIDER – PREMIUM / MICRO

B

	PLC		Cables		Connection		MICROADAPTER					
	Input/Output cards		Standard		Screw	Tension clamp	Adapter + relay					
	Manufacturer code	Number/Type of channels	Order No.	Quantity			Adapter			Inputs or outputs with relay		
							Order No.	Quantity	Page	Order No.	Quantity	Page
DI	TSX DEY 16FK	16 DI	7789303xxx	1			8773510000	2	B.46	8596060000	16	B.51
							8773530000			8596080000		
	TSX DEY 32D2K	32 DI	7789303xxx	2			8773510000	4	B.46	8596060000	32	B.51
						8773530000	8596080000					
	TSX DEY 64D2K	64 DI	7789303xxx	4			8773510000	8	B.46	8596060000	64	B.51
						8773530000	8596080000					
DO	TSX DSY 32T2K	32 DO	7789303xxx	2			8773620000	4	B.47	8533640000	32	B.49
							8773600000			8533660000		
	TSX DSY 64T2K	64 DO	7789303xxx	4			8773600000	8	B.47	8533640000	64	B.49
						8773620000	8533660000					
DI/DO	TSX DMZ 64DTK	32 DI	7789303xxx	4			8773510000	4	B.49	8596060000	32	B.51
		32 DO					8773600000	4	B.47	8533640000	32	B.49





























Note

- The cards should be used in positive logic.
- The adapters should receive power from an external supply.
- The last 3 digits of the cable code indicate its length in decimetres. For example, if the code ends in 100, the cable would be 10 m long.
- The relays indicated in the table are 24 V DC for the digital input cards. These relays can be replaced by MICROSERIES relays with other voltages, from 5 V DC to 230 V AC.

Email: sales@cambia



PLC Siemens S7-300 / ET-200M

	PLC		Cables		Connection		MICROADAPTER					
	Input/Output cards		Standard		Screw	Tension clamp	Adapter + relay					
	Manufacturer code	Number/Type of channels	Order No.	Quantity			Adapter			Inputs or outputs with relay		
					Order No.	Quantity	Page	Order No.	Quantity	Page		
DI	6ES7321-1BH00-0AA0	16 DI	7789235xxx	1			8773510000	2	B.46	8596060000	16	B.51
							8773530000			8596080000		
	6ES7321-1BH01-0AA0	16 DI	7789235xxx	1			8773510000	2	B.46	8596060000	16	B.51
							8773530000			8596080000		
	6ES7321-1BH02-0AA0	16 DI	7789235xxx	1			8773510000	2	B.46	8596060000	16	B.51
							8773530000			8596080000		
	6ES7321-1BH50-0AA0	16 DI	7789235xxx	1			8773510000	2	B.46	8596060000	16	B.51
							8773530000			8596080000		
	6ES7321-1BH80-0AA0	16 DI	7789235xxx	1			8773510000	2	B.46	8596060000	16	B.51
							8773530000			8596080000		
6ES7321-1BH81-0AA0	16 DI	7789235xxx	1			8773510000	2	B.46	8596060000	16	B.51	
						8773530000			8596080000			
6ES7321-1BH82-0AA0	16 DI	7789235xxx	1			8773510000	2	B.46	8596060000	16	B.51	
						8773530000			8596080000			
6ES7321-1BL00-0AA0	32 DI	7789861xxx	1			8773510000	4	B.46	8596060000	32	B.51	
						8773530000			8596080000			
6ES7321-1BL80-0AA0	32 DI	7789861xxx	1			8773510000	4	B.46	8596060000	32	B.51	
						8773530000			8596080000			
6ES7321-7RD00-0AB0	16 DI	7789235xxx	1			8773510000	2	B.46	8596060000	16	B.51	
						8773530000			8596080000			
DO	6ES7322-1BH00-0AA0	16 DO	7789235xxx	1			8773600000	2	B.47	8533640000	16	B.49
							8773620000			8533660000		
	6ES7322-1BH01-0AA0	16 DO	7789235xxx	1			8773600000	2	B.47	8533640000	16	B.49
							8773620000			8533660000		
6ES7322-1BH81-0AA0	16 DO	7789235xxx	1			8773600000	2	B.47	8533640000	16	B.49	
						8773620000			8533660000			
6ES7322-1BL00-0AA0	32 DO	7789861xxx	1			8773600000	4	B.47	8533640000	32	B.49	
						8773620000			8533660000			









Note

- The cards should be used in positive logic.
- The adapters should receive power from an external supply.
- The last 3 digits of the cable code indicate its length in decimetres. For example, if the code ends in 100, the cable would be 10 m long.
- The relays indicated in the table are 24 V DC for the digital input cards. These relays can be replaced by MICROSERIES relays with other voltages, from 5 V DC to 230 V AC.

B

PLC SIEMENS – S7400

B

	PLC		Cables		Connection		MICROADAPTER					
	Input/Output cards		Standard		Screw	Tension clamp	Adapter + relay					
	Manufacturer code	Number/Type of channels	Order No.	Quantity			Adapter			Inputs or outputs with relay		
						Order No.	Quantity	Page	Order No.	Quantity	Page	
DI	6ES7421-1BL00-0AA0	32 DI	833591xxxx	1			8773510000	4	B.46	8596060000	32	B.51
							8773530000			8596080000		
DI	6ES7421-1BL01-0AA0	32 DI	833591xxxx	1			8773510000	4	B.46	8596060000	32	B.51
							8773530000			8596080000		
DO	6ES7422-1BL00-0AA0	32 DO	833591xxxx	1			8773600000	4	B.47	8533640000	32	B.49
							8773620000			8533660000		
	6ES7422-7BL00-0AB0	32 DO	833591xxxx	1			8773600000	4	B.47	8533640000	32	B.49
						8773620000	8533660000					

Note

- The cards should be used in positive logic.
- The adapters should receive power from an external supply.
- The last 3 digits of the cable code indicate its length in decimetres. For example, if the code ends in 100, the cable would be 10 m long.
- The relays indicated in the table are 24 V DC for the digital input cards. These relays can be replaced by MICROSERIES relays with other voltages, from 5 V DC to 230 V AC.

Email: sales@cambia

Email: sales@cambia.a.c

MICRO-INTERFACE digital

**Adaptor and solution
for MICROSERIES relays and optocouplers**

Adapter for relays and opto modules MICROSERIES with screw or tension-clamp connection.

MI8DI-S F10

Input adapter with 10-pole female header



MI8DI-S SUB D15

Input adapter with 25-pole SUB-D connector

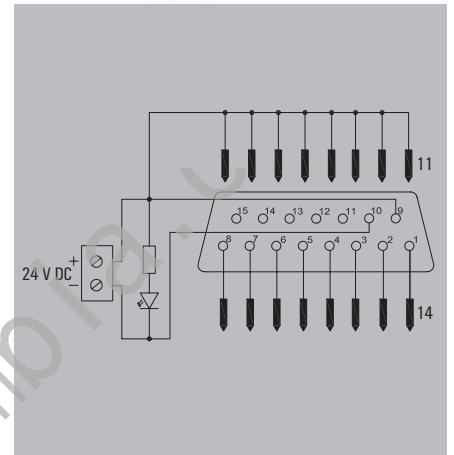
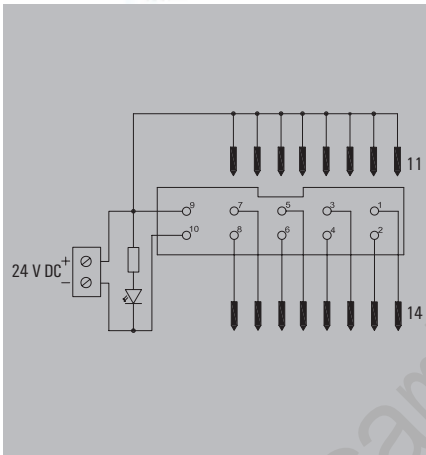

Technical data

Connection data
Connection on control side
Number of poles (control side)
Nominal input data
Operating voltage
Max. current per channel
Operating voltage (supply)
Nominal output data
Ambient temperature (operational)
Storage temperature
Approvals
Insulation coordination (EN50178)
Rated insulation voltage
Surge voltage category
Pollution severity level
Insulation test voltage

Plug-in connector acc. IEC 603-1 / DIN 41651
10-pole plug
30 V UC
0.5 A
24 V DC ± 10%
0...+55°C
-20...+85 °C
CE; cULus; GOSTME25
< 50 V AC
III
2
0.35 kVAC

IEC 60603/DIN41612 plug-in connectors
25-pole plug
30 V UC
0.5 A
24 V DC ± 10%
0...+55°C
-20...+85 °C
CE; cULus; GOSTME25
< 50 V AC
III
2
0.35 kVAC

Dimensions
Clamping range, min. / max. [supply]
Length x width

Screw connection	Tension clamp connection
2.5 mm ² / 0.13 mm ²	2.5 mm ² / 0.13 mm ²
48 mm / 59 mm	48 mm / 59 mm

Screw connection	Tension clamp connection
2.5 mm ² / 0.13 mm ²	2.5 mm ² / 0.13 mm ²
48 mm / 59 mm	48 mm / 59 mm

Note

Ordering data

Screw connection
Tension clamp connection

Type	Height	Order No.
MI8DI-S F10 S	53 mm	8773510000
MI8DI-Z F10 S	53 mm	8773530000

Type	Height	Order No.
MI8DI-S SUB D15S	53 mm	8773460000
MI8DI-Z SUB D15S	53 mm	8773490000

Note

MI8DI-S = screw connection
MI8DI-Z = tension clamp connection

MI8DI-S = screw connection
MI8DI-Z = tension clamp connection

Accessories

Note

Adaptor and solution for MICROSERIES relays and optocouplers

Adapter for relays and opto modules MICROSERIES with screw or tension-clamp connection.

MI8DO-S F10

Output adapter with 25-pole SUB-D connector



MI8DO-S SUB D15

Output adapter, 10-pole female header

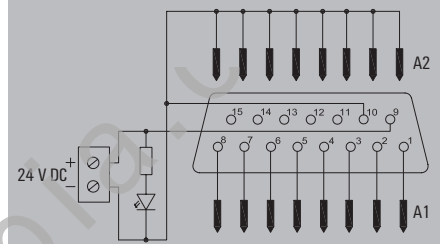
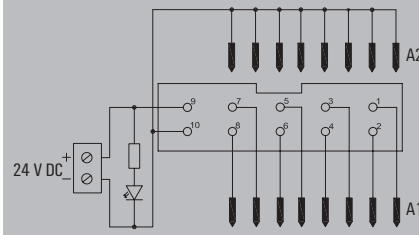

Technical data

Connection data

Connection on control side
Number of poles (control side)

Nominal input data

Operating voltage
Max. current per channel
Operating voltage (supply)

Nominal output data

Ambient temperature (operational)
Storage temperature
Approvals

Insulation coordination (EN50178)

Rated insulation voltage
Surge voltage category
Pollution severity level
Insulation test voltage

Plug-in connector acc. IEC 603-1 / DIN 41651
10-pole plug

30 V UC
0.5 A
24 V DC ± 10%

0...+55°C
-20...+85 °C
CE; cULus; GOSTME25

< 50 V AC
III
2
0.35 kVAC

IEC 60603/DIN41612 plug-in connectors
25-pole plug

30 V UC
0.5 A
24 V DC ± 10%

0...+55°C
-20...+85 °C
CE; cULus; GOSTME25

< 50 V AC
III
2
0.35 kVAC

Dimensions

Clamping range, min. / max. [supply]
Length x width

Screw connection

2.5 mm² / 0.13 mm²
48 mm / 59 mm

Tension clamp connection

2.5 mm² / 0.13 mm²
48 mm / 59 mm

Screw connection

2.5 mm² / 0.13 mm²
48 mm / 59 mm

Tension clamp connection

2.5 mm² / 0.13 mm²
48 mm / 59 mm

Note

Ordering data

Screw connection
Tension clamp connection

Type	Height	Order No.
MI8DO-S F10 S	53 mm	8773600000
MI8DO-Z F10 S	53 mm	8773620000

Type	Height	Order No.
MI8DO-S SUB D15S	53 mm	8773550000
MI8DO-Z SUB D15S	53 mm	8773570000

Note

MI8DO-S = screw connection
MI8DO-Z = tension clamp connection

MI8DO-S = screw connection
MI8DO-Z = tension clamp connection

Accessories

Note

MICROSERIES - Relay Couplers

**1 CO contact
AC / DC / UC coil**

This module may be used as a universal interface between the control and actuator for connecting small and medium loads.

- Interchangeable relay modules, can also be exchanged with an opto module
- 6.1 mm wide
- The plug-in cross-connection at the input and output minimises the wiring task

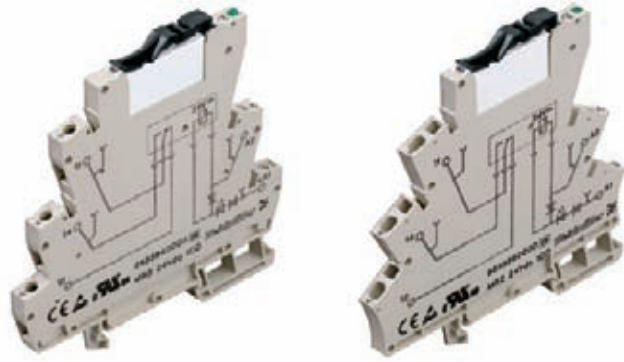

B

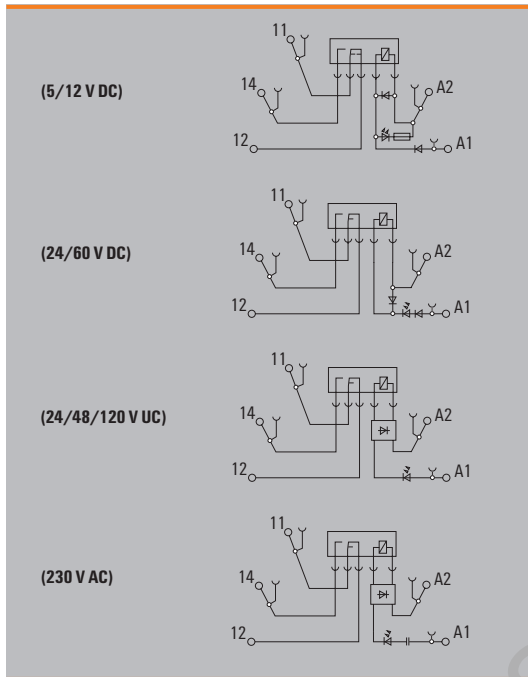

Technical data

Output	
Max. switching voltage, AC / Continuous current	250 V / 6 A
Min. switching power	12 V / 10 mA
Switch-on delay / Switch-off delay	6.2 ms / 3.9 ms
Contact material	AgSnO
Mechanical service life	20 x 10 ⁶ switching cycles
Max. switching frequency at rated load	0.1 Hz
Rated data	
Status indicator / Free-wheel diode	Green LED / Yes
Reverse polarity protection	Available
Ambient temperature (operational)	25 °C...+55 °C
Storage temperature	40 °C...+60 °C
Humidity	40°C / 93% rel. humidity, no condensation
Insulation coordination (EN 50 178)	
Standards	DIN EN 50178
Rated voltage	300 V
Impulse withstand voltage	4 kV (1.2/50 µs)
Clearance and creepage distances for control side - load side	≥ 5.5 mm
Surge voltage category	
Pollution severity level	
Protective separation acc. to VDE 0106 part 101	

Dimensions	Screw connection	Tension clamp connection
Clamping range (nominal / min. / max.)	mm ² 2.5 / 0.5 / 4	1.5 / 0.5 / 2.5
Length x width x height	mm 93 / 6.1 / 92	94 / 6.1 / 91
Note	Cross-connections and markers - refer to MICROSERIES accessories	

Applications

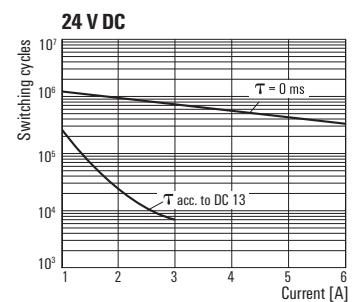
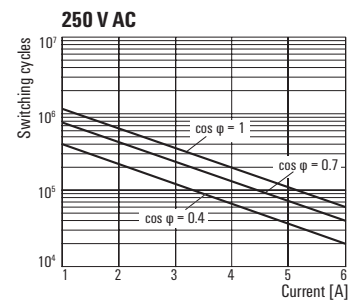
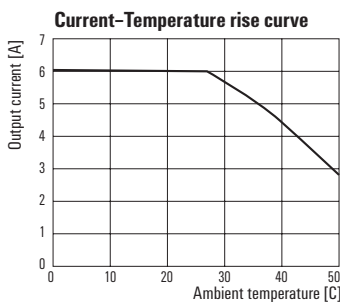
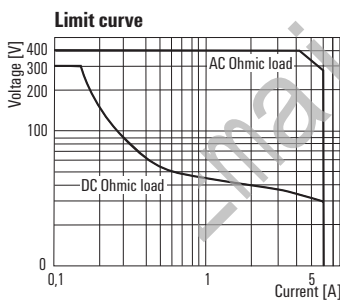

1 CO contact
AC / DC / UC coil

B

Ordering data

	5 V DC 1CO	12 V DC 1CO	24 V DC 1CO	24 V UC 1CO
Input				
Rated control voltage	5 V DC ±20 %	12 V DC ±20 %	24 V DC ±20 %	24 V UC ±10 %
Rated current AC				11 mA
Rated current DC	38.5 mA	17 mA	6.6 mA	6.4 mA
Power rating	193 mW	210 mW	160 mW	270 mVA / 154 mW
AC Response/dropout Volt				
DC Response/dropout Volt	3.2 V / 1.6 V	6.4 V / 2.5 V	15.4 V / 6.5 V	15.8 V / 7 V
AC pickup/dropout current				
DC pickup/dropout current	21,6 mA / 8 mA	8.4mA/2.4mA	4mA/1.2mA	3.6mA/1.3mA
Approvals	CE; CSA; cULus; cURus	CE; CSA; cULus; cURus	CE; CSA; cULus; cURus	CE; CSA; cULus; cURus

Ordering data

Relay with socket				
Screw connection	Type	MRS 5VDC 1CO	MRS 12VDC 1CO	MRS 24VDC 1CO
	Order No.	8556080000	8556070000	8533640000
Tension clamp connection	Type	MRZ 5VDC 1CO	MRZ 12VDC 1CO	MRZ 24VDC 1CO
	Order No.	8556150000	8556140000	8533660000

Ordering data

Spare relay (pluggable)				
	Type	RSS113005 05VDC-REL1U	RSS113012 12VDC-REL1U	RSS113024 24VDC-REL1U
	Order No.	4061580000	4061610000	4060120000

Note

Ordering data

	48 V UC 4CO	60 V DC 1CO	120 V UC 1CO	230 V AC 1CO
Input				
Rated control voltage	48 V UC ±10 %	60 V DC ±20 %	120 V UC +10 % / -15 %	230 V AC ±10 %
Rated current AC	5 mA		3.5 mA ±15 %	7.6 mA
Rated current DC	4 mA	3,3 mA	3.5 mA ±15 %	
Power rating	190 mW	200 mW	0.42 VA, 360 mW	1.75 VA, 210 mW
AC Response/dropout Volt			60 V / 37 V	103 V / 49 V
DC Response/dropout Volt	29 V / 11 V	35 V / 11 V	60 V / 21 V	
AC pickup/dropout current			1.8 mA / 1.1 mA	5 mA / 2.5mA
DC pickup/dropout current	2,2 mA / 1,3 mA	1,6 mA / 0,6 mA	1,8 mA / 0,5 mA	
Approvals	CE; CSA; cULus; cURus	CE; CSA; cULus; cURus	CE; CSA; cULus; cURus	CE; CSA; cULus; cURus

Ordering data

Relay with socket				
Screw connection	Type	MRS 48VUC 1CO	MRS 60VDC 1CO	MRS 120VUC 1CO
	Order No.	8556040000	8556060000	8556030000
Tension clamp connection	Type	MRZ 48VUC 1CO	MRZ 60VDC 1CO	MRZ 120VUC 1CO
	Order No.	8556110000	8556130000	8556100000

Ordering data

Spare relay (pluggable)				
	Type	RSS113048 48VDC-Rel1U	RSS113060 60VDC-REL1U	RSS113060 60VDC-REL1U
	Order No.	4061620000	4061630000	4061630000

Note

MICROSERIES - Relay Couplers

1 CNA

Special Variants

Variant of the 24 V DC actuator model:

- Potential free connection for direct connection of actuators at the output using bridging

Variant of the 120 V AC-RC model:

- The RC device of the input guarantees safe connection thresholds, e.g. with leak currents at the control side

230 V UC variant:

- It can also be connected to the input with DC signals

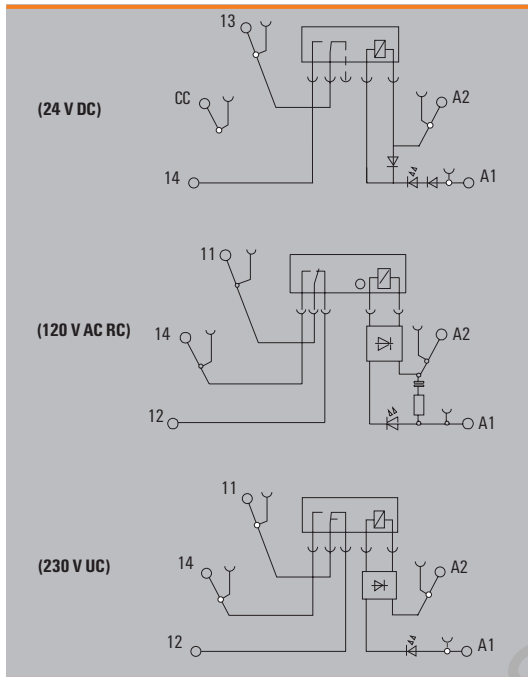
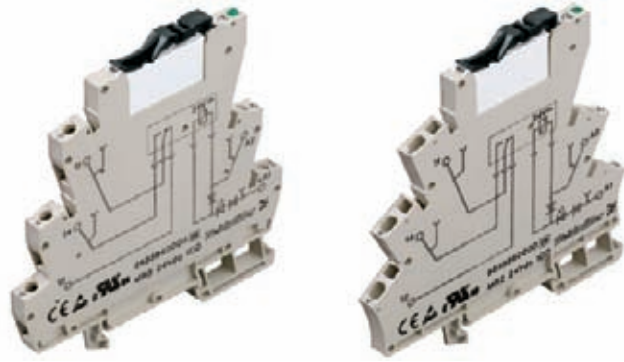

Technical data

Output	
Max. switching voltage, AC / Continuous current	250 V / 6 A
Min. switching power	12 V / 10 mA
Switch-on delay / Switch-off delay	6.6 ms / 5.8 ms
Contact material	AgSnO
Mechanical service life	20 x 10 ⁶ switching cycles
Max. switching frequency at rated load	0.1 Hz
Rated data	
Status indicator / Free-wheel diode	Green LED / Yes
Reverse polarity protection	Available
Ambient temperature (operational)	25 °C...+55 °C
Storage temperature	40 °C...+60 °C
Humidity	40°C / 93% rel. humidity, no condensation
Insulation coordination (EN 50 178)	
Standards	DIN EN 50178
Rated voltage	300 V
Impulse withstand voltage	4 kV (1.2/50 µs)
Clearance and creepage distances for control side - load side	≥ 5.5 mm
Surge voltage category	
Pollution severity level	
Protective separation acc. to VDE 0106 part 101	
Dimensions	
Clamping range (nominal / min. / max.)	mm ² 2.5 / 0.5 / 4
Length x width x height	mm 93 / 6.1 / 92
Note	
Cross-connections and markers - refer to MICROSERIES accessories	

Ordering data

	24 V DC ACT	120 V AC 1C0 RC	230 V UC 1C0
Input			
Rated control voltage	24 V DC ±20 %	120 V AC + 10 % / -15 %	230 V UC +10 % / -15 %
Rated current AC		7 mA	3.5 mA
Rated current DC	6.6 mA		2.9 mA
Power rating	160 mW	0.84 VA	0.8 VA / 660 mW
AC Response/dropout Volt		60 V / 37 V	146 V / 104 V
DC Response/dropout Volt	15.4 V / 6.5 V		153 V / 101 V
AC pickup/dropout current		4.5 mA / 3.7 mA	
DC pickup/dropout current	4 mA / 1.2 mA		1.7 mA / 0.7 mA
Approvals	CE; cULus	CE; cULus	CE

Ordering data				
Relay with socket				
Screw connection	Type	MRS 24VDC ACT	MRS 120VUC 1C0 RC	MRS 230VUC 1C0
	Order No.	8660920000	8825970000	8825990000
Tension clamp connection	Type	MRZ 24VDC ACT	MRZ 120VUC 1C0 RC	MRZ 230VUC 1C0
	Order No.	8660910000	8825960000	8825980000

Ordering data				
Spare relay (pluggable)				
Type		RSS113024 24VDC-REL1U	RSS113060 60VDC-REL1U	RSS113060 60VDC-REL1U
	Order No.	4060120000	4061630000	4061630000

Note				

1 change-over
with hard gold plated contacts AC / DC / UC coil

This module may be used as a universal interface between the control and actuator for connecting small and medium loads.

- Interchangeable relay modules, can also be exchanged with an opto module
- 6.1 mm wide
- The plug-in cross-connection at the input and output minimises the wiring task

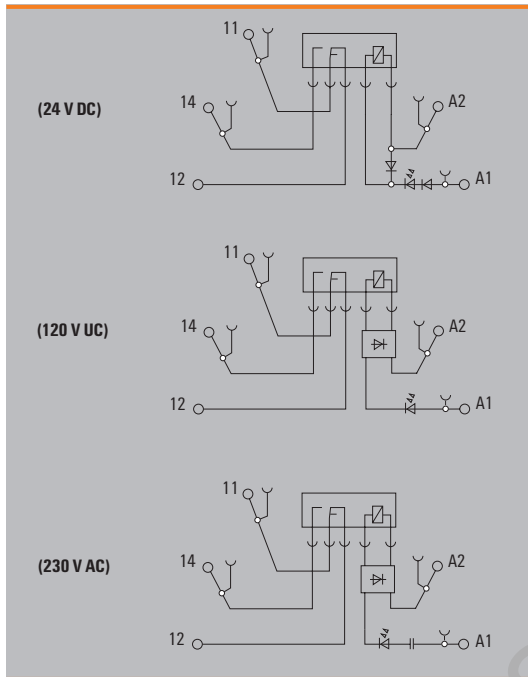
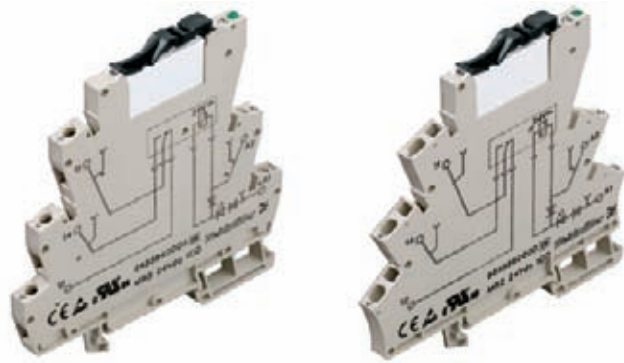

Technical data

Output	
Max. switching voltage, AC / Continuous current	250 V / 6 A
Min. switching power	1 V / 1 mA
Switch-on delay / Switch-off delay	6.6 ms / 5.8 ms
Contact material	AgSnO 5µm Au
Mechanical service life	20 x 10 ⁶ switching cycles
Max. switching frequency at rated load	0.1 Hz
Rated data	
Status indicator / Free-wheel diode	Green LED / Yes
Reverse polarity protection	Available
Ambient temperature (operational)	25 °C...+55 °C
Storage temperature	40 °C...+60 °C
Humidity	40°C / 93% rel. humidity, no condensation
Insulation coordination (EN 50 178)	
Standards	DIN EN 50178
Rated voltage	300 V
Impulse withstand voltage	4 kV (1.2/50 µs)
Clearance and creepage distances for control side - load side	≥ 5.5 mm
Surge voltage category	
Pollution severity level	
Protective separation acc. to VDE 0106 part 101	
Dimensions	
Clamping range (nominal / min. / max.)	mm ² 2.5 / 0.5 / 4
Length x width x height	mm 93 / 6.1 / 92
Note	Cross-connections and markers - refer to MICROSERIES accessories

Ordering data

	24 V DC 1CO Au	120 V UC 1CO Au	230 V AC 1CO Au
Input			
Rated control voltage	24 V DC ±20 %	120 V UC +10 % / -15 %	230 V AC ±10 %
Rated current AC		3.5 mA ±15 %	7.6 mA
Rated current DC	6.6 mA	3.5 mA ±15 %	
Power rating	160 mW	0.42 VA, 360 mW	1.75 VA, 210 mW
AC Response/dropout Volt		60 V / 37 V	103 V / 49 V
DC Response/dropout Volt	15.4 V / 6.5 V	71 V / 22 V	
AC pickup/dropout current		1.8 mA / 1.1 mA	5 mA / 2.5mA
DC pickup/dropout current	4 mA / 1.2 mA	1.8 mA / 0.5 mA	
Approvals	CE; cULus	CE; cULus	CE; cULus

Ordering data				
Relay with socket				
Screw connection	Type	MRS 24VDC 1CO 5uAu	MRS 120VUC 1CO 5uAu	MRS 230VAC 1CO 5uAu
	Order No.	8596060000	8652030000	8596050000
Tension clamp connection	Type	MRZ 24VDC 1CO 5uAu	MRZ 120VUC 1CO 5uAu	MRZ 230VAC 1CO 5uAu
	Order No.	8596080000	8652040000	8596070000

Ordering data				
Spare relay (pluggable)				
Type		RSS112024 24VDC-REL1U	RSS112060 60VDC-REL1U	RSS112024 24VDC-REL1U
	Order No.	4061590000	4061600000	4061590000

Note			
	Allows safely connecting loads of up to 100 - 60 V AC/DC and 1 - 300 mA. Connecting higher loads may damage the gold plating.	Allows safely connecting loads of up to 100 - 60 V AC/DC and 1 - 300 mA. Connecting higher loads may damage the gold plating.	Allows safely connecting loads of up to 100 - 60 V AC/DC and 1 - 300 mA. Connecting higher loads may damage the gold plating.

MICROSERIES - Relay Couplers

1 CO contact AC / DC / UC coil

This module may be used as a universal interface between the control and actuator for connecting small and medium loads.

- Interchangeable relay modules, can also be exchanged with an opto module
- 6.1 mm wide
- The plug-in cross-connection at the input and output minimises the wiring task

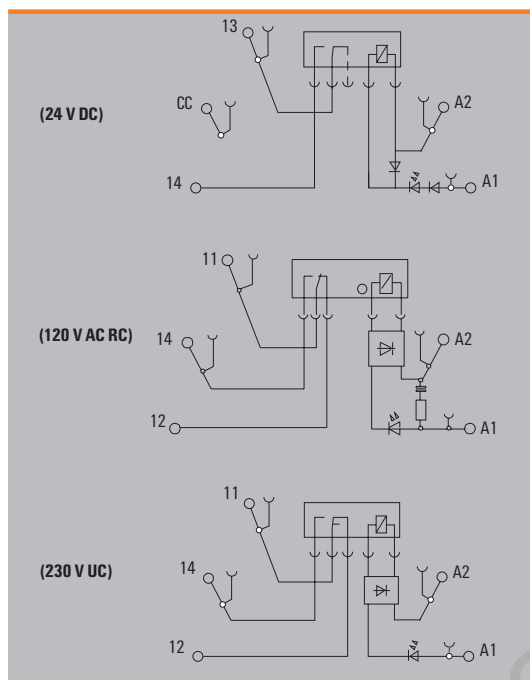
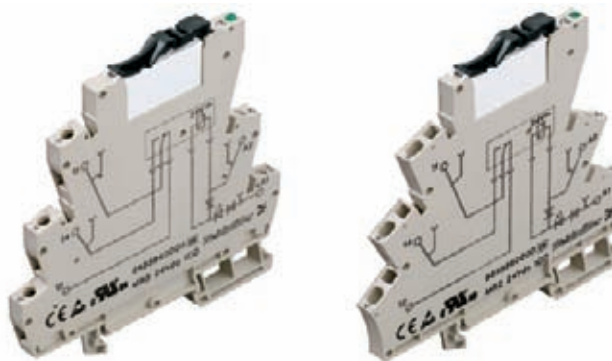

Technical data

Output	
Max. switching voltage, AC / Continuous current	250 V / 6 A
Min. switching power	12 V / 10 mA
Switch-on delay / Switch-off delay	5.8 ms / 6.9 ms
Contact material	AgSnO
Mechanical service life	20 x 10 ⁶ switching cycles
Max. switching frequency at rated load	0.1 Hz
Rated data	
Status indicator / Free-wheel diode	Green LED / Yes
Reverse polarity protection	Available
Ambient temperature (operational)	25 °C...+55 °C
Storage temperature	40 °C...+60 °C
Humidity	40°C / 93% rel. humidity, no condensation
Insulation coordination (EN 50 178)	
Standards	DIN EN 50178
Rated voltage	300 V
Impulse withstand voltage	4 kV (1.2/50 µs)
Clearance and creepage distances for control side - load side	≥ 5.5 mm
Surge voltage category	
Pollution severity level	
Protective separation acc. to VDE 0106 part 101	
Dimensions	
Clamping range (nominal / min. / max.)	mm ² 2.5 / 0.5 / 4
Length x width x height	mm 93 / 6.1 / 92
Note	
Cross-connections and markers - refer to MICROSERIES accessories	

Ordering data

Input	12 V DC 1CO	24 V DC 1CO	24 V UC 1CO
Rated control voltage	12 V DC ±20 %	24 V DC ±20 %	24 V UC ±10 %
Rated current AC			11 mA
Rated current DC	17 mA	6.6 mA	6.4 mA
Power rating	210 mW	160 mW	270 mVA / 154 mW
AC Response/dropout Volt			
DC Response/dropout Volt	6.4 V / 2.5 V	15.4 V / 6.5 V	15.8 V / 7 V
AC pickup/dropout current			
DC pickup/dropout current	8.4mA/2.4mA	4 mA / 1.2 mA	3.6mA/1.3mA
Approvals	CE; cULusEX	Cl. I Div. 2; CE	CE; cULusEX

Ordering data		12 V DC 1CO	24 V DC 1CO	24 V UC 1CO
Relay with socket				
Screw connection	Type	MRS 12VDC 1CO C1D2	MRS 24VDC 1CO C1D2	MRS 24VUC 1CO C1D2
	Order No.	8967340000	8967350000	8967360000
Screw connection	Type			
	Order No.			
Spare relay (pluggable)				
Screw connection	Type	RSS113012 12VDC-REL1U	RSS113024 24VDC-REL1U	RSS113024 24VDC-REL1U
	Order No.	4061610000	4060120000	4060120000
Note				

RSS Relay
1 CO contact DC coil

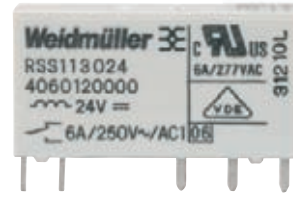

Cross Connection

Useful life of AgSnO2 material contact

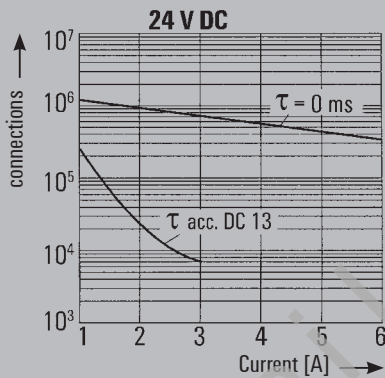
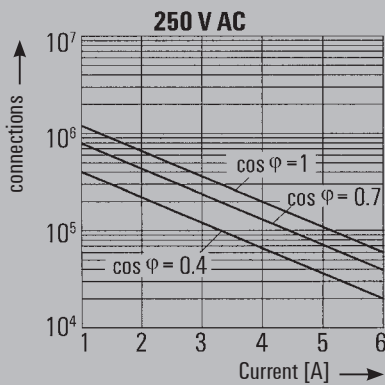

Dimensional drawing

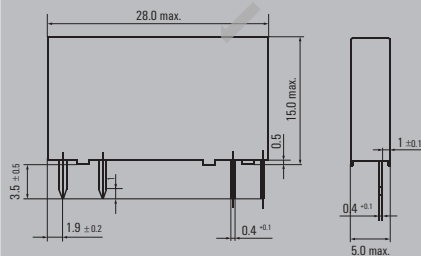

Technical data

Number and type of contacts	1 change-over contact
Contact	1 CC
Switching current	6 A
Connection/disconnection time	250 V AC / 400 V AC
Switching power	1500 VA
Contact material / recommended for minimum loads	AgSnO2 12 V, 10 mA AgSnO2 5 μ Au 1 V, 1 mA ¹⁾
CNA bounce time	1 ms
CNC bounce time	5 ms

Other data

Type of flammability acc. UL	V-0
Room temperature	-40 ... +85 °C
Frequency of max. connection with / without nominal load	6/1200 connections per minute
Connection/disconnection time	5 / 2.5 ms
Bounce time of contact normally open/closed	1.5 / 5 ms
Type of box protection	IP 67

¹⁾ recommended connection power: μ W up to 0.25 W (depending on the load status) to 2.5 W the level will continue being effective to approx. 20,000 connection cycles

Ordering data

	Type	Qty.	Order No.
5V coil voltage, 1 CO contact	RSS 113005	20	4061580000
12V coil voltage, 1 CO contact	RSS 113012	20	4061610000
24V coil voltage, 1 CO contact	RSS 113024	20	4060120000
48V coil voltage, 1 CO contact	RSS 113048	20	4061620000
60V coil voltage, 1 CO contact	RSS 113060	20	4061630000
24V coil voltage, 1 CO contact, 5 μ Au ¹⁾	RSS 112024	20	4061590000
60V coil voltage, 1 CO contact, 5 μ Au ¹⁾	RSS 112060	20	4061600000

Code of the RSS type of relay

Type code

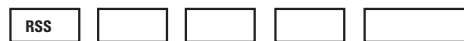

Type RIDER Signal Slim

Model 1 Printing, vertical, washable

Type of contact 1 1 Changeover contact

Contact material 2 AgSnO₂ htv
3 AgSnO₂

Coil
005 5 V DC
012 12 V DC
024 24 V DC
048 48 V DC
060 60 V DC

MICROSERIES - Relay Couplers

MOS / MOZ 3...48 V DC / 0.1 A

Universal interface between the control and the sensor/actuator

- Plug-in cross-connection ZQV 4N
- Interchangeable solid state relay
- 6.1 mm wide
- Screw or tension clamp connection
- For mounting on TS35

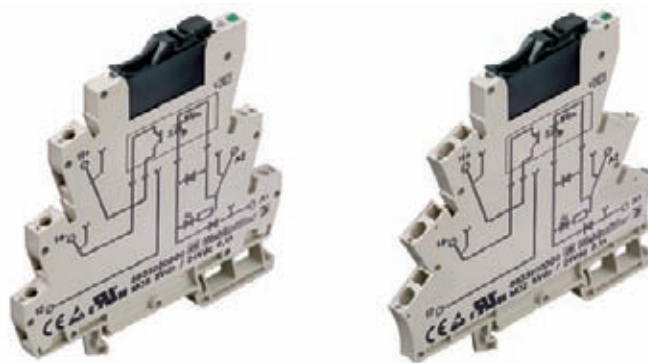

Technical data

Load side	
Rated switching voltage	3...48 V DC
Rated switching current	0.1 A
Voltage drop at max. load	≤ 1 V
Leakage current	
Short-circuit-proof	No
Rated data	
Ambient temperature (operational)	-25 °C...+50 °C
Storage temperature	-40 °C...+60 °C
Humidity	40 °C / 93% rel. humidity, no condensation
Insulation coordination (EN 50 178)	
Standards	DIN EN 50178
Rated voltage	300 V
Rated impulse withstand voltage	4 kV (1.2 / 50 µs)
Clearance and creepage distances for control side - load side	≥ 5.5 mm
Surge voltage category	
Pollution severity level	

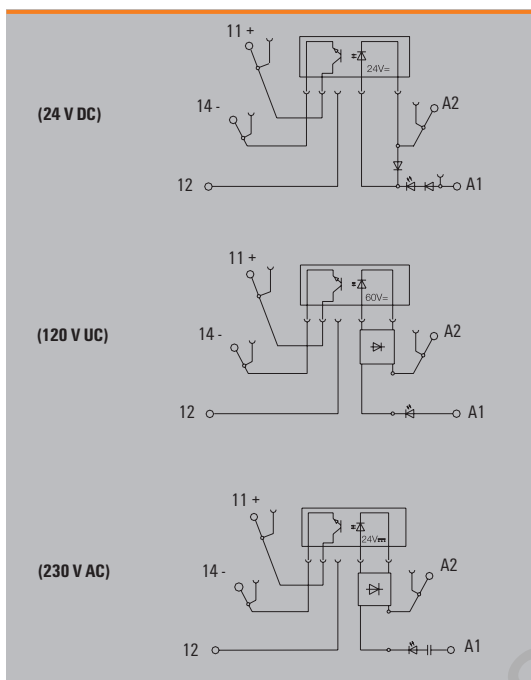

Dimensions	Screw connection	Tension clamp connection
Clamping range (nominal / min. / max.)	mm ² 2.5 / 0.5 / 4	1.5 / 0.5 / 2.5
Length x width x height	mm 92 / 6.1 / 93	91 / 6.1 / 94
Note	Cross-connections and markers - refer to MICROSERIES accessories	

Ordering data

Control side	5 V DC / 24 V DC 0,1 A	24 V DC / 24 V DC 0,1 A	120 V UC / 24 V DC 0,1 A	230 V AC / 24 V DC 0,1 A
Rated control voltage	5 V DC ±20 %	24 V DC ±20 %	120 V UC +10 % / -15 %	230 V AC ±10 %
Power rating	35 mW ±10 %	140 mW	340 mW / 0.4 VA	1.7 VA
Input frequency	max. 10 Hz	300 Hz	DC: 10 Hz / AC: 3 Hz	max. 10 Hz
Switch-on delay	< 6.5 ms	35 µs	< 6.5 ms	< 6.5 ms
Switch-off delay	< 10 ms	355 µs	< 10 ms	< 10 ms
Approvals	CE; cULus	CE; cULus	CE; cULus	CE; cULus

Ordering data	5 V DC / 24 V DC 0,1 A	24 V DC / 24 V DC 0,1 A	120 V UC / 24 V DC 0,1 A	230 V AC / 24 V DC 0,1 A
Relay with socket				
Screw connection	Type: MOS 5VDC / 24VDC 0,1A Order No. 8633020000	Type: MOS 24VDC / 24VDC 0,1A Order No. 8607340000	Type: MOS 120VUC / 24VDC 0,1A Order No. 8607690000	Type: MOS 230VAC / 24VDC 0,1A Order No. 8607710000
Tension clamp connection	Type: MOZ 5VDC / 24VDC 0,1A Order No. 8633010000	Type: MOZ 24VDC / 24VDC 0,1A Order No. 8607360000	Type: MOZ 120VUC / 24VDC 0,1A Order No. 8607730000	Type: MOZ 230VAC / 24VDC 0,1A Order No. 8607750000

Ordering data	5 V DC / 24 V DC 0,1 A	24 V DC / 24 V DC 0,1 A	120 V UC / 24 V DC 0,1 A	230 V AC / 24 V DC 0,1 A
Spare relay (pluggable)				
Type	SSS RELAIS 5V/24V 0,1ADC	SSS RELAIS 24V/24V 0,1ADC	SSS RELAIS 60V/24V 0,1ADC	SSS RELAIS 24V/24V 0,1ADC
Order No.	4064320000	4061180000	4061230000	4061180000

Note				
-------------	--	--	--	--

Plug-in solid-state relay

SSS Relay

Connection current 100 mA

SSS Relay

Connection current 2 A

SSS Relay

Connection current 1 A



Technical data

Input	5 V DC	24 V DC	60 V DC
Nominal Control Voltage	5 V DC	24 V DC	60 V DC
Min./max. control voltage	0.8 V DC/6 V DC	16 V DC/30 V DC	52 V DC/72 V DC
Control current to $U_N = 24 V$	4.1 mA	7 mA \pm 10 %	2.8 mA \pm 10 %
Release Voltage	2.5 V DC	10 V DC	40 V DC
Control Circuit Resistance	-	approx. 4 k Ω	approx. 20 k Ω
Output	Bipolar transistor		
Load voltage	3 ... 48 V DC		
Permanent current to $U_A > 5 V DC$	100 mA DC		
Voltage drop (activation)	< 1 V DC		
Insulation	2.5 kV		
Test voltage between I/O	2.5 kV		

Other data			
Service temperature	-20 °C ... +60 °C		
Storage temperature scale	-40 °C ... +70 °C		
Weight	3.65 g		
Humidity	40°C/93% rel. humidity without condensation		
Approvals	UL		
*TU 20 °C			

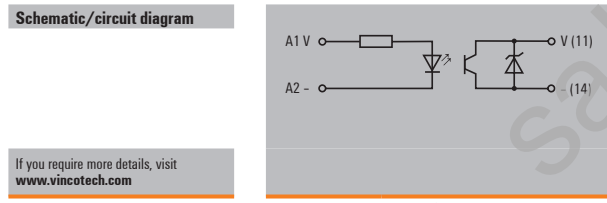

If you require more details, visit www.vincotech.com

Ordering data

Nominal Control Voltage	Type	Order No.
5 V DC	SSS Relais 5 V / 24 V 0.1 A DC	4064320000
24 V DC	SSS Relais 24 V / 24 V 0.1 A DC	4061180000
60 V DC	SSS Relais 60 V / 24 V 0.1 A DC	4061230000

Input	5 V DC	24 V DC	60 V DC
Nominal Control Voltage	5 V DC	24 V DC	60 V DC
Min./max. control voltage	2.5 V DC/6 V DC	18 V DC/30 V DC	35 V DC/72 V DC
Control current to $U_N = 24 V$	9 mA	7 mA \pm 10 %	3.0 mA \pm 10 %
Release Voltage	0.8 V DC	10 V DC	20 V DC
Control Circuit Resistance	approx. 5 k Ω	approx. 3.2 k Ω	approx. 16 k Ω
Output	MOS-FET		
Load voltage	3 ... 33 V DC		
Permanent current to $U_A > 5 V DC$	2 A DC		
Voltage drop (activation)	< 120 mV DC		
Insulation	2.5 kV		
Test voltage between I/O	2.5 kV		

Other data			
Service temperature	-20 °C ... +60 °C		
Storage temperature scale	-40 °C ... +70 °C		
Weight	3.65 g		
Humidity	40°C/93% rel. humidity without condensation		
Approvals	UL		
*TU 20 °C			

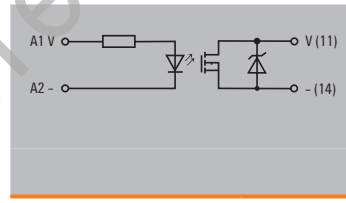

If you require more details, visit www.vincotech.com

Input	24 V DC	60 V DC
Nominal Control Voltage	24 V DC	60 V DC
Min./max. control voltage	18 ... 30 V DC	35 ... 72 V DC
Control current to $U_N = 24 V$	3.1 mA \pm 10 %	3.1 mA \pm 10 %
Release Voltage	20 V DC	20 V DC
Control Circuit Resistance	20 k Ω	20 k Ω
Output	TRIAC	
Load voltage	24 ... 240 V AC	
Permanent current to $U_A > 5 V DC$	1 A AC	
Voltage drop (activation)	< 1 V AC	
Insulation	2.5 kV	
Test voltage between I/O	2.5 kV	

Other data		
Service temperature	-20 °C ... +60 °C	
Storage temperature scale	-40 °C ... +70 °C	
Weight	3.65 g	
Humidity	40°C/93% rel. humidity without condensation	
Approvals	UL	
*TU 20 °C		

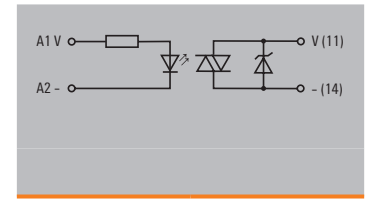

If you require more details, visit www.vincotech.com

Dimensional drawing

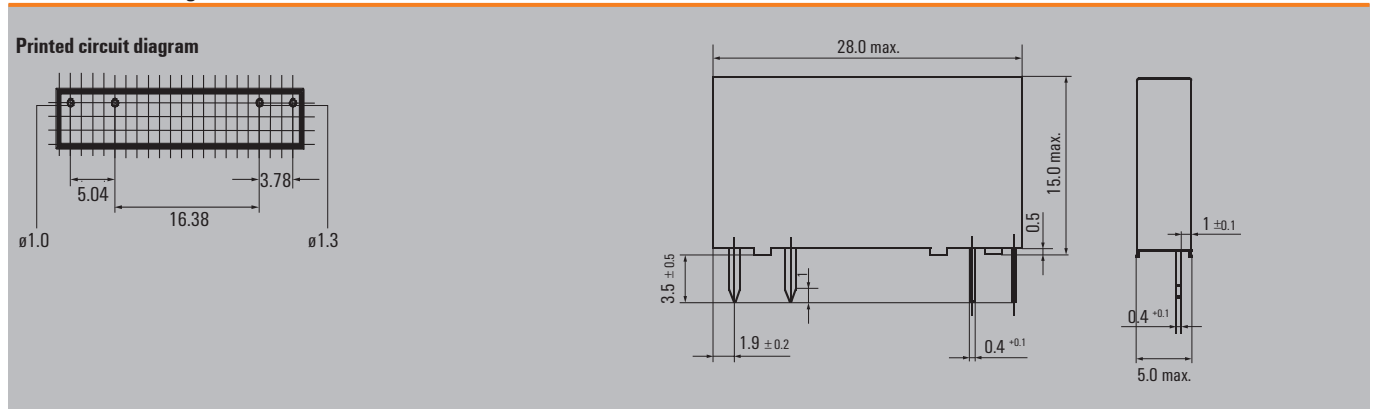

Email: sales@cambia.com